

The role of abdominal compliance, the neglected parameter in critically ill patients — a consensus review of 16.

Part 2: measurement techniques and management recommendations

Manu L.N.G. Malbrain¹, Inneke De laet^{1,2}, Jan J. De Waele², Michael Sugrue³, Alexander Schachtrupp⁴, Juan Duchesne⁵, Gabrielle Van Ramshorst⁶, Bart De Keulenaer⁷, Andrew W. Kirkpatrick⁸, Siavash Ahmadi-Noorbakhsh⁹, Jan Mulier¹⁰, Paolo Pelosi¹¹, Rao Ivatury¹², Francisco Pracca¹³, Marcelo David¹⁴, Derek J. Roberts¹⁵

¹*Intensive Care Unit and High Care Burn Unit, ZiekenhuisNetwerkAntwerpen, ZNA Stuivenberg, Lange Beeldekensstraat 267, B-2060 Antwerpen 6, Belgium*

²*Surgical ICU, University Hospital, UZ Gent, Gent, Belgium*

³*Department of Surgery, Letterkenny General Hospital, Donegal Ireland*

⁴*Department of Medical Science, B.Braun, Carl- Braun Str. 1, 34243 Melsungen, Germany*

⁵*Tulane School of Medicine Health Science Center, Section of Trauma and Critical Care Surgery Department of Surgery and Anesthesia, New Orleans, LA, USA*

⁶*Department of Surgery, Erasmus MC, Room Ff-219, P.O. Box 2040, 3000 CA Rotterdam, Netherlands*

⁷*Intensive Care Unit, Fremantle Hospital, Fremantle, Western Australia, Australia and School of Surgery, The University of Western Australia, 35 Sterling Hwy, Crawley WA 6009, Australia*

⁸*Regional Trauma Services, Foothills Medical Center, Calgary, Alberta, Canada*

⁹*Preclinical Intensive Care Research Unit (PICRU), School of Anatomy, Physiology and Human Biology, The University of Western Australia, Perth, Western Australia, Australia*

¹⁰*Department of Anaesthesiology, AZ Sint Jan Brugge-Oostende AV, Ruddershove 10, 8000 Brugge, Belgium*

¹¹*Department of Surgical Science and Integrated Diagnostics, The University of Genoa, Genoa, Italy*

¹²*Professor emeritus, former Chair, Division of Trauma, Critical Care and Emergency Surgery, VCU Medical Center, 1200 East Broad Street, Richmond, VA, USA*

¹³*Department of Intensive Care, Hospital de Clínicas, University of the Republic, Montevideo, Uruguay*

¹⁴*MSc Biomechanical Electrical Engineer, The Jerusalem College of Engineering, Hebrew University of Jerusalem, Jerusalem, Israel*

¹⁵*Departments of Surgery and Community Health Sciences, University of Calgary and the Foothills Medical Centre, Calgary, Alberta, Canada*

Abstract

The recent definitions on intra-abdominal pressure (IAP), intra-abdominal volume (IAV) and abdominal compliance (C_{ab}) are a step forward in understanding these important concepts. They help our understanding of the pathophysiology, aetiology, prognosis, and treatment of patients with low C_{ab} .

However, there is still a relatively poor understanding of the different methods used to measure IAP, IAV and C_{ab} and how certain conditions may affect the results. This review will give a concise overview of the different methods to assess and estimate C_{ab} ; it will list important conditions that may affect baseline values and suggest some therapeutic options. Abdominal compliance (C_{ab}), defined as a measure of the ease of abdominal expansion, is measured differently than IAP. The compliance of the abdominal wall is only a part of the total abdominal pressure-volume (PV) relationship. Measurement or estimation of C_{ab} is difficult at the bedside and can only be done in a case of change (removal or

addition) in IAV. The different measurement techniques will be discussed in relation to *decreases* (ascites drainage, haematoma evacuation, gastric suctioning) or *increases* in IAV (gastric insufflation, laparoscopy with CO₂ pneumoperitoneum, peritoneal dialysis). More specific techniques using the interactions between the thoracic and abdominal compartment during positive pressure ventilation will also be discussed (low flow PV loop, respiratory IAP variations, respiratory abdominal variation test, mean IAP and abdominal pressure variation), together with the concept of the polycompartment model. The relation between IAV and IAP is linear at low IAV and becomes curvilinear and exponential at higher volumes. Specific conditions in relation to increased (previous pregnancy or laparoscopy, gynoid fat distribution, ellipse-shaped internal abdominal perimeter) or decreased C_{ab} (obesity, fluid overload, android fat distribution, sphere-shaped internal abdominal perimeter) will be discussed as well as their impact on baseline IAV, IAP, reshaping capacity and abdominal workspace volume.

Finally, we suggest possible treatment options in situations of unadapted IAV according to existing C_{ab}, which results in high IAP. A large overlap exists between the treatment of patients with abdominal hypertension and those with low C_{ab}. The C_{ab} plays a key role in understanding the deleterious effects of unadapted IAV on IAP and end-organ perfusion and function. If we can identify patients with low C_{ab}, we can anticipate and select the most appropriate surgical treatment to avoid complications such as IAH or ACS.

Key words: abdominal pressure, abdominal volume, abdominal compliance, abdominal wall, pressure volume relation, diagnosis, treatment, abdominal hypertension, abdominal compartment, laparoscopy, risk factors

Anaesthesiology Intensive Therapy 2014, vol. 46, no 5, 406–432

Abdominal compliance (C_{ab}) is defined as a measure of the ease of abdominal expansion, which is determined by the elasticity of the abdominal wall and diaphragm [1]. It should be expressed as the change in IAV per change in IAP (ml/mm Hg). The given C_{ab} (albeit rarely measured) at a certain point together with the corresponding actual IAV will determine the resulting IAP, as discussed in a recent review [2]. Correct measurement or estimation of C_{ab} together with identification of patients at risk for poor C_{ab} will help avoid progression from normal IAP to IAH to ACS and its associated complications [3]. Vice versa, for a given laparoscopic insufflation pressure (limited at 14 mm Hg) the C_{ab} will determine the additional 'workspace' volume to perform the laparoscopic intervention [4, 5]. As suggested by others, the C_{ab} plays a key-role in understanding the deleterious effects of unadapted IAV on IAP and end-organ perfusion, although at present it is one of the most neglected parameters in critically ill patients [2].

This narrative review article will describe in detail the different methods for the measurement and/or estimation of abdominal wall compliance. Measurement of C_{ab} is difficult at the bedside and can only be done in a case of change (removal or addition) in IAV. The different measurement techniques will be discussed in relation to *decreases* (ascites drainage, haematoma evacuation, gastric suctioning) or *increases* in IAV (gastric insufflation, laparoscopy with CO₂ pneumoperitoneum, peritoneal dialysis). More specific techniques to estimate C_{ab} using the interactions between the thoracic and abdominal compartment during positive pressure ventilation will also be discussed (low flow PV loop, respiratory IAP variations, respiratory abdominal variation test, mean IAP and abdominal pressure

variation), together with the concept of the polycompartment model [6].

Finally, we will examine interactions between the thoracic and abdominal compartment and the implications of alterations in C_{ab} for clinical practice in critically ill patients or those undergoing laparoscopy. This review is the second part of a concise overview on the key-role of abdominal compliance in critically ill patients; the two papers should therefore be seen as a whole.

METHODS

The methods with regard to writing this review are the same as previously described [2]. While preparing for the fifth World Congress on ACS (WCACS), several international surgical, trauma, and medical critical care specialists recognised the lack of existence and uniformity among current definitions for abdominal compliance. The 5th WCACS meeting was held on 10–13 August 2011, in Orlando, Florida, USA and afterwards the present co-authors corresponded, providing feedback to questions and issues raised. During the whole writing process, a systematic or structured Medline and PubMed search was conducted to identify relevant studies relating to the topic using the search terms 'abdominal compliance' in combination with 'measurement' and 'treatment' or 'management'. The content of this paper will focus on the different methods to measure or estimate IAP, IAV and C_{ab}, followed by guidelines and recommendations for clinical management of patients with low C_{ab}. The reader must take into account that, as pointed out in the title, this manuscript is the reflection of the consensus of 16 experts in the field; therefore, some of the statements are based on expertise and clinical judgement only.

MEASUREMENT

INTRA-ABDOMINAL PRESSURE (IAP)

As explained previously, and because of the fluid-like nature of the abdomen following Pascal's law, the IAP can be measured in nearly every body part. Rectal, uterine, inferior vena cava, bladder and gastric pressure measurements have all been described [7]. The use of direct intraperitoneal pressure measurement cannot be advocated in patients because of the complication risks (bleeding, infection) and should only be used in an experimental setting or when a drainage catheter is already in place (paracentesis, peritoneal dialysis, surgical drain). Bladder pressure measurements have been put forward as the gold standard with the technique suggested in the WSACS consensus guidelines [1]. Intermittent screening for IAH by measuring the height of the urine column as an estimate for IAP (with the FoleyManometer, Holtech Medical, Charlottenlund, Denmark) is a cost-effective method [8]. Recently continuous IAP monitoring by means of a balloon-tipped nasogastric probe also became available [9–11]. It is beyond the scope of this review to list the different measurement methods in detail, as these are discussed elsewhere [7, 12, 13].

INTRA-ABDOMINAL VOLUME (IAV)

The abdominal volume is difficult to measure. As most body organs do not have a linear relationship between their volume and internal pressure, the value of the calculated compliance depends on the body volume. Therefore a calculated compliance, or its reciprocal elastance, usually has no clinical value if the corresponding volume is not given. One way to overcome this problem is to look at the clinically important part of the pressure volume relationship and linearise it. A high IAP does not correlate well with a high IAV [14].

ANTHROPOMORPHY AND IAV

Body Mass Index (BMI): Anthropomorphic-based indices for estimation of IAV have been described in obesity [15]. The best-known index is the body mass index (BMI). However BMI is not an index of IAV, but rather an index of body mass according to body height. BMI does not correlate with C_{ab} but does correlate with IAP at the resting volume (i.e. when the abdomen is not inflated) [16, 17].

$$BMI = \text{body mass} \times \text{height}^{-2} [\text{kg m}^{-2}]$$

Studies have shown that BMI is correlated to IAP, but only in healthy individuals, and not always in critically ill patients [18, 19]. With regard to obesity, only central obesity, the so-called 'apple-shaped body' (with central fat redistribution above the waist), is related to increased IAP, whereas the pear-shaped form (with peripheral fat distribution below

the waist) is not (Fig. 1) [20]. The latter body shape is also associated with a better prognosis whereas the former is linked to the metabolic syndrome with diabetes, arterial hypertension, abdominal hypertension, high triglycerides, insulin resistance, and low HDL cholesterol [21–23]. The apple- and pear-shaped individual probably has an increased tendency towards an increased IAP due to the compressive effects of the fat mass. However, in theory, these effects will be more pronounced in the former. The patients with an apple-shaped internal abdominal perimeter usually have an increased amount of intra-abdominal visceral fat to such an extent that the abdominal peritoneum has become sphere-shaped. The resulting effect is that they have a non-linear PV relation at very high additional IAV. All other obese and non-obese apple- and pear-shaped individuals show a rather constant C_{ab} or a linear PV relation up to a pressure of 15 mm Hg. This is in contrast with many other mammals like pigs or sheep where the PV relationship is non-linear from the beginning with a varying compliance. Hence data from animal literature cannot uniformly be extrapolated to humans [24].

Abdominal perimeter: The abdominal perimeter (or circumference), often used in the past, correlates reasonably with IAV, but poorly with IAP [25]. Changes in abdominal perimeter over time on the other hand may correlate well with changes in IAP [25].

Waist to hip ratio: Another parameter is the waist to hip ratio (WHR) or the waist: hip girth. The waist is the smallest horizontal girth between the rib cage and iliac crest where the hip is the largest horizontal girth between waist and thigh. The WHR correlates with IAP in men only [15]. Nor-

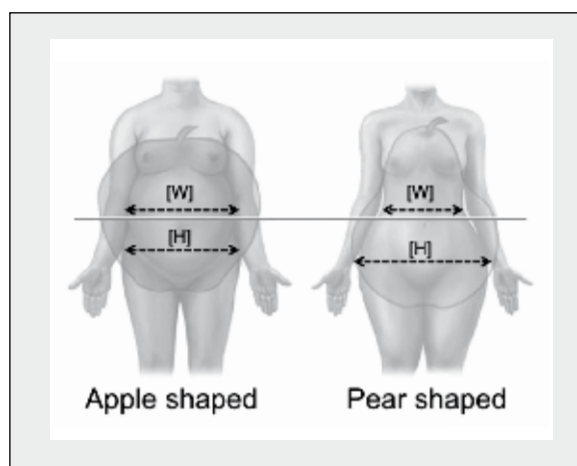

Figure 1. Example of central fat distribution. The so-called apple-shape is depicted on the left (with fat distribution above the waist (W) and hip (H) and high IAP), while the so-called pear-shape is depicted on the right (with maximal fat distribution below the waist and around the hip, normal IAP, and lower waist-to-hip ratio)

mal WHR is below 0.8 and it is considered pathologically increased if it is above 1.0.

Sagittal abdominal diameter: The sagittal abdominal diameter (SAD) is defined as the height between the table or bed and the apex of the abdomen [15].

$$IAP = -0.03 \times BMI + 0.8 \times SAD + 0.02 \times age \text{ (-8.8 for men)}$$

In cases of increased SAD, the IAP may be increased. However, IAP is influenced by a multitude of other factors, including previous pregnancy and surgery. All these parameters have been linked to increased IAP and abdominal distension in the obese, but not in the critically ill; therefore they cannot be used for prognostication or relation to IAV.

Abdominal volume index: a promising index is the abdominal volume index (AVI) calculated using volume formulas for a cylinder (V_{cil}) and a cone (V_{cone}), with the radius r and height h :

$$V_{cil} = \pi \times r^2 \times h$$

$$V_{cone} = (\pi \times r^2 \times h) / 3$$

The formula developed for calculating AVI estimates the overall abdominal volume between the symphysis pubis and the xiphoid process. This measure theoretically includes intra-abdominal fat and adipose volumes, with the waist [W] and the hip [H] dimensions:

$$AVI = [2 \times [W]^2 + 0.7 \times ([W] - [H])^2] / 1,000$$

Although this index is superior to BMI, WHR, and waist circumference, it has not been correlated to IAP to date [26].

IMAGING TECHNIQUES FOR DETERMINING IAV

Recently, techniques for estimating abdominal volume via three-dimensional (3D) ultrasound (US), water-suppressed breath hold magnetic resonance imaging (MRI), and computed tomography (CT) have been described. These techniques have not yet gained entrance to the intensive care unit (ICU). Although 3D US cannot measure IAV in toto, it estimates the volumes of separate intra-abdominal organs. Organ volumes can be determined by slicing through collected images and recording truncated pyramidal volumes. MRI and CT techniques calculate the visceral and subcutaneous fat volume or thus the volume of the adipose tissue (VAT). The VAT is related to SAD and IAP [15].

$$VAT = 0.8 \times SAD - 11.5 \text{ (men)}$$

$$VAT = 0.4 \times SAD - 4.9 \text{ (women)}$$

$$IAP = 1.3 \times VAT + 3.8 \text{ (men)}$$

$$IAP = 2.2 \times VAT + 3.4 \text{ (women)}$$

The CT images are representative of the distribution of the attenuation coefficient μ of the object in a certain area [27]. The analysis is based on the close correlation between the X-ray attenuation in a given volume of tissue or voxel (the CT unit of volume) and the physical density of that volume of tissue. The X-ray attenuation of tissues is expressed by CT numbers or Hounsfield Units (HUs). This CT number is obtained, in any given voxel, by determining the percentage of radiation absorbed by that volume of tissue. As with any X-ray technique, the greater the absorption, the less the radiation hitting the CT detector. The attenuation scale arbitrarily assigns to bone a value of +1,000 HU (complete absorption), water a value of 0 HU, and air a value of -1,000 HU (no absorption). Blood and tissues are within an overall range of between +20–40 HU. Indeed, the relationship between the physical density and volume in any abdominal region of interest, assuming the specific weight of the tissue is equal to 1, may be expressed as follows:

$$\text{volume}_{gas} / (\text{volume}_{gas} + \text{volume}_{tissue}) =$$

$$\text{mean CT number}_{observed} / (\text{CT number}_{gas} - \text{CT number}_{water})$$

Rearranging this equation, it is possible to compute for any abdominal region of interest (contiguous voxels) in which the total volume is known, the volume of gas, the volume (and the weight) of tissue, and the gas/tissue ratio (Fig. 2).

For example, a voxel of -1,000 HU is exclusively composed of gas, a voxel with 0 HU is exclusively composed of

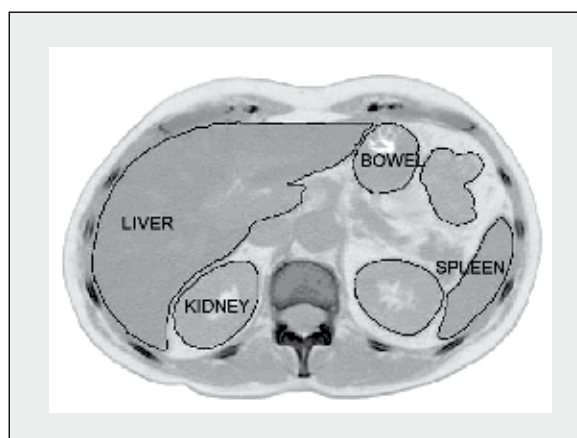

Figure 2. Volumetric abdominal computed tomography. Abdominal CT scan image with the different abdominal organs (liver, spleen, kidneys and bowel) manually outlined

water (or 'tissue'), and a voxel with -500 HU is composed of approximately 50% gas and 50% water (or tissue). While the density and volume values are given from the programme, the weight value may be calculated with the formula:

$$weight = (-1,000 - CT_{mean}) / -1,000$$

Because the physical density is a ratio, the same increase of density may derive from less gas or more tissue. Unfortunately, the voxel is a 'black box' in which it is impossible to distinguish which component(s), blood, or other tissues are responsible for the changes in CT density. In the standard 10 mm axial image (matrix size: 256×256), the volume of a voxel $1.5 \times 1.5 \times 10$ mm is 22.5 mm^3 . Current CT scanners are now capable of axial images as thin as 0.5 mm (compared to 10 mm, greater matrix: 512×512), and voxels would be proportionately smaller. Smaller voxels increase spatial resolution, decrease volume averaging, and improve the reliability of CT density readings. It is therefore possible to compute the distribution of CT numbers in the area of interest (from $-1,000$ HU to $+300$ HU for the bowel at each step of 100 HU, from -10 HU to $+100$ HU for the liver and the spleen and from -100 HU to $+100$ HU for the kidneys at each step of 1 to 10 HU): the number of voxels included in each compartment is expressed as a percentage of the total number of voxels considered. Knowing the CT number frequency distribution of a given region of interest and its total volume it is possible to compute, rearranging the above equation, the amount of tissue in each compartment (Fig. 3).

Quantitative CT analysis assessing volume, density and weight of abdominal organs may be promising tools for the future [28–31]. When assessing additional IAV, a reasonable correlation has been found between the volume measured

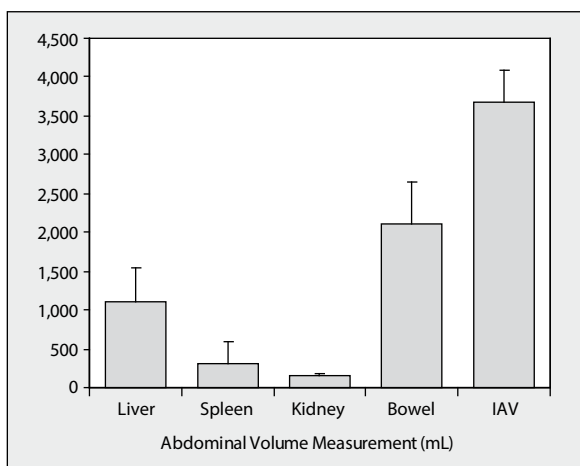

Figure 3. Intra-abdominal volume measurement measured by quantitative CT analysis. The average volume (mL) of the liver, spleen, kidney, bowel and the total estimated intra-abdominal volume (IAV) as measured by quantitative CT analysis (adapted from [27])

by CT and the volume of CO_2 insufflated during laparoscopy, suggesting that both methods are reliable [29].

ABDOMINAL COMPLIANCE (CAB)

QUALITATIVE MEASUREMENT OF ABDOMINAL WALL TENSION DURING PALPATION

The grade of indentation at the site where the punctual force is applied can be measured during palpation of the abdomen. Palpation examines intra-abdominal tension and passive and active muscle tension. Increased muscle tension is a symptom of peritonitis. The force F necessary to make a certain indent d into the abdominal wall is correlated with IAP and C_{ab} :

$$F/d \approx IAP$$

ABDOMINAL TENSIO METER

In a study investigating 76 pregnant women, C_{ab} was found to be inversely related to gestational age and BMI [32]. In another preliminary study, van Ramshorst et al. examined the abdominal wall tension (AWT) in two corpses [33]. The abdominal cavity can be considered as a cylindrical pressure vessel ($t < R/4$) with $t = \text{abdominal wall thickness}$ and $R = \text{radius}$ (Fig. 4, 5). The tensile strength can be calculated:

$$\sigma_w = [(P_i - P_o) R] / t$$

with:

σ_w = stress in abdominal wall (tension)

P_i = internal pressure (IAP)

P_o = external pressure

The same authors examined in a later experiment the abdomens of 14 corpses that were insufflated with air [34]. The IAP was measured at intervals up to 20 mm Hg. At each interval, abdominal wall tension (AWT) was measured five times at six points (Fig. 6, 7). In 42 volunteers, AWT was measured at five points in supine, sitting, and standing positions during various respiratory manoeuvres. The authors found significant correlations between IAP and AWT in corpses (the best correlations were found at the epigastric region). *In vivo* measurements showed that AWT was on average 31% higher in men compared to women and increased from expiration to inspiration to Valsalva's manoeuvre. AWT was highest at the standing position, followed by supine and sitting positions. The BMI did not influence AWT.

RESPIRATORY INDUCTANCE PLETHYSMOGRAPHY (RIP)

Other techniques to study the interactions between the abdomen and thorax are combined thoracic and abdominal plethysmography and electrical impedance to-

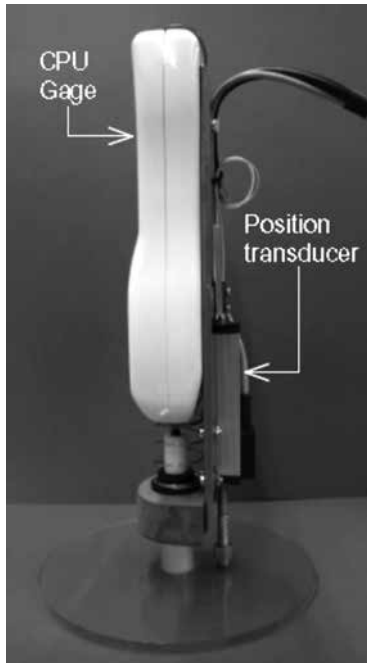

Figure 4. Tensiometer to measure abdominal compliance and pressure. Initial device to measure the abdominal wall tension by measuring force and distance (indentation) at the site where the punctual force is applied; force and distance were registered simultaneously by using a CPU Gauge (Model RX Aikom, manufactured in Japan) and a position transducer (Series LWH, NovoTechnik, manufactured in Germany). Both sensors were supported by an assembly that enabled an indenter, connected to the measuring end of the force meter, to pass through an acrylic foot. The foot of the assembly defined a zero point and enabled the indenter to apply the force on the point of measurement and the distance sensor to measure the vertical displacement of the indenter (adapted from [33])

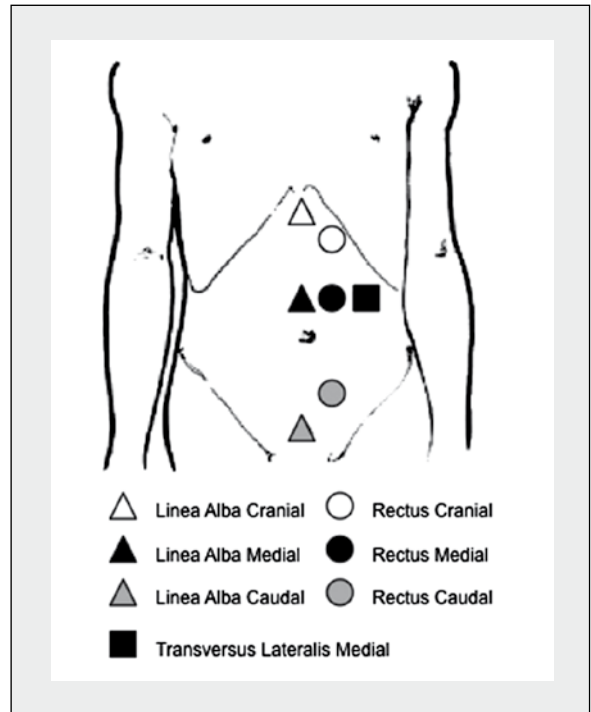

Figure 5. Tensiometer to measure abdominal compliance and pressure. Seven points were measured during initial study: three on the linea alba, three on the rectus abdominis muscle, and finally one over the lateral transverse muscle. The measurements were solely performed on one half of the abdomen, assuming abdominal symmetry (adapted from [33])



Figure 6. Tensiometer to measure abdominal compliance and pressure. The new prototype used for measuring AWT consisted of a built-in force and distance sensor, attached to a handheld personal digital assistant (PDA, HP IPAQ). The diameter of the circle-shaped base of the device is 72 mm. The tip of the instrument is shaped like one half of a sphere and has a diameter of 18 mm, with a total surface area of approx. 5.1 cm². The shape of the tip was chosen due to the extensive use of this shape in industrial hardness measurements of materials. The size of the tip was chosen due to its comparability to the conventional instrument by which abdominal tension is estimated, which is the human finger. This device can measure the amount of force (N) needed to indent a certain distance (mm), which is then visualised on the PDA in graphics (adapted from [34])

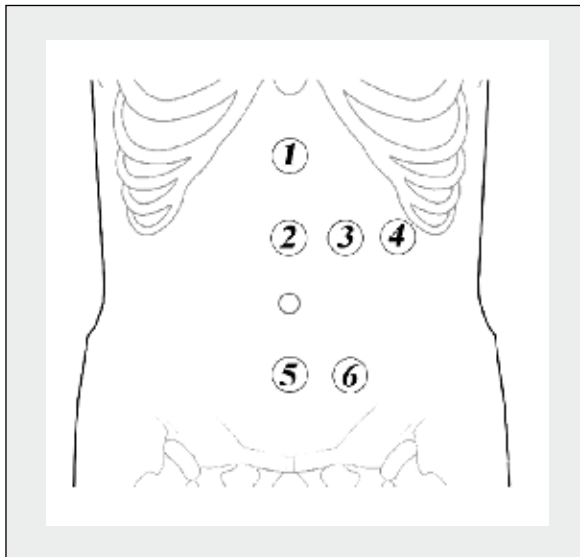

Figure 7. Tensiometer to measure abdominal compliance and pressure. Measurement points. Six points, derived from anatomical structures, were marked on each abdominal wall: 5 cm caudal to the xiphoid bone (point 1), 5 cm cranial to the umbilicus (point 2), 5 cm left to point 2 (point 3), 10 cm left to point 2 (point 4), 5 cm cranial to the pubic bone (point 5), and an extra point, 5 cm left to point 5 (point 6) (adapted from [34])

mography [35]. This allows the simultaneous recording of pressure and volume excursions within the abdomen and thorax to identify abnormal pressure and movements that can be caused by alterations in compliance of the different compartments. The chest wall motions can be converted to volume changes. The relation between rib-cage (RC) and abdominal (AB) signals and tidal volume (TV) can be described by the following equation:

$$TV = \alpha \times RC + \beta \times AB$$

Here, α and β are the coefficients describing the relationship between motion and volume changes in the rib cage and the abdominal compartment, and RC and AB are the dimensional changes of rib cage and abdomen. The IAV can be calculated as follows:

$$IAV = \kappa \times [(\alpha/\beta) \times RC + AB]$$

Where α/β is the weighing coefficient and κ is a factor converting dimension change to volume in litres. By plotting IAV versus IAP, the effects of the different actions of the thoracic and abdominal compartments can be studied (Fig. 8).

In a study involving five normal subjects, abdominal compliance (C_{ab}) was measured using respiratory inductance plethysmography. In the supine position, C_{ab} was $250 \pm 100 \text{ mL (mm Hg)}^{-1}$. Changing to an upright position reduced C_{ab} to $48 \pm 20 \text{ mL (mm Hg)}^{-1}$ [36].

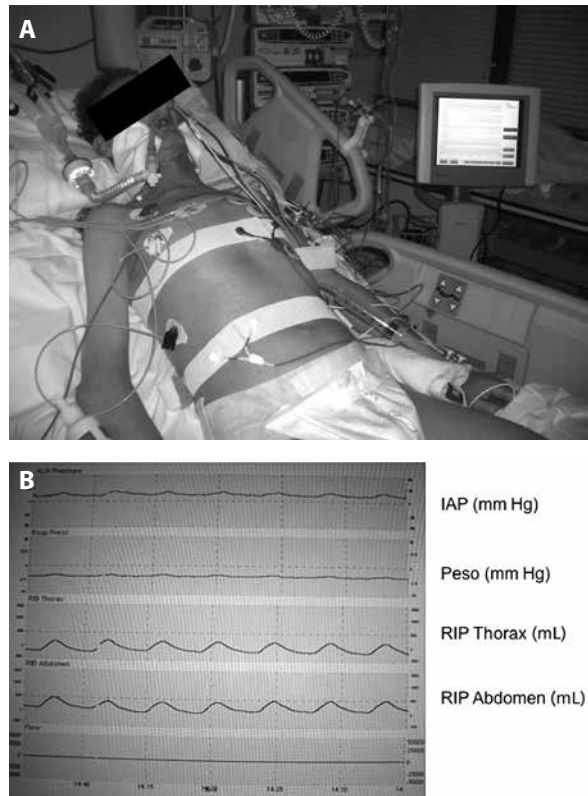

Figure 8. Respiratory Inductance Plethysmography (RIP). **A** — patient set-up with thoracic and abdominal RIP belt connected to BiCore monitor (Cardinal Health, Dublin, OH, USA); **B** — sample tracings that can be obtained with BiCore monitor (Cardinal Health)

In another study in three normal test persons, fluid was instilled into the stomach and subsequently withdrawn. Volume changes of abdomen, lung, and rib cage were assessed using magnetometry. In the 70° HOB position, mean C_{ab} was $49 \pm 20 \text{ mL (mm Hg)}^{-1}$. Interestingly, from the volume used for gastric distension, 33% went into a decrease in lung volume, 40% into an increase in rib cage volume, and 26% into an increase in abdominal volume. The authors concluded that the interactions among the rib cage, abdomen, and diaphragm are such as to defend against large changes in end-expiratory lung volume in the face of abdominal distension [37].

PV RELATIONSHIP DURING LAPAROSCOPY WITH CO₂ PNEUMOPERITONEUM

It has been observed that the compliance of the abdominal cavity decreases when additional volume is added to the abdominal cavity [37]. This was confirmed clinically by McDougall et al. and Abu-Rafea et al. who examined 41 and 100 patients respectively during laparoscopy with CO₂ pneumoperitoneum [38, 39]. The linear abdominal volume-pressure curve changed to a rather exponential shape when a pressure of 15 mm Hg was achieved by insufflating 3 and 4.5 L of CO₂ in each study (Fig. 9, derived from [38, 39]).

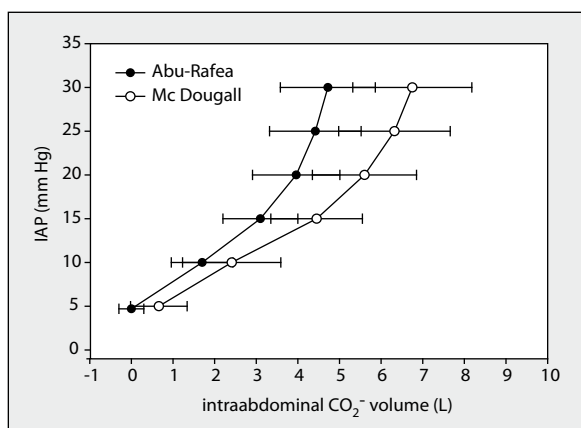

Figure 9. Abdominal pressure volume relationship during laparoscopy. Relationship between intra-abdominally inflated CO₂ volume and resulting acute pressure increase in 41 (McDougall) and 100 patients (Abu-Rafea) during laparoscopic procedures [38, 39]. The initial part of the abdominal compliance PV curve is linear when insufflation pressures are limited to 15 mm Hg and normal Cab ranges between 333 mL (mm Hg)⁻¹ [38] and 400 mL (mm Hg)⁻¹ [39]

In their studies, the initial abdominal compliance at the beginning of the CO₂ inflation varied between 333 and 400 mL (mm Hg)⁻¹ and at higher IAV (with corresponding IAP above 15 mm Hg) the C_{ab} dropped to 60 and 90 mL (mm Hg)⁻¹ respectively [38, 39]. Other studies have also examined C_{ab} by assessment of IAP values with at least two corresponding IAV measurements before and after CO₂-insufflation [40–43]. The derived mean C_{ab} values in these studies ranged between 175 and 733 mL (mm Hg)⁻¹ (Table 1).

Three successive studies during laparoscopy were performed by Mulier et al. to analyse the possible linear relationship between 0 and 15 mm Hg [16]. During insufflation of the abdomen to create a pneumoperitoneum for laparoscopy, both IAP and insufflated volume can be measured and are used to calculate the abdominal PV relationship (APVR). The Verres needle, however, does not allow APVR measurement unless the flow is stopped. The initial linear part of the APVR is described by an elastance E and a pressure at zero volume (P_{v0}). Elastance and P_{v0} were calculated by fitting to a linear relation:

$$E = 1 / C$$

$$IAP = E \times IAV + P_{v0}$$

First, an accurate, linear relationship was identified using a mathematical model with an elastance, E , or its reciprocal the compliance C and with a pressure at zero volume, P_{v0} . This function was stable and could be used to describe the abdominal characteristics of patients. With these characteristics, the effects of drugs, position, and ventilation can be evaluated. Leakage or absorption of CO₂ did

not affect the measurements in a second study. In a third study, the minimal amount of data needed to determine the parameters of the mathematical model was identified. Three pressure-volume measurements were sufficient to describe all cases with the exception of the patients with apple-shaped abdominal fat. The conclusion was that body weight, BMI, and the use of muscle relaxation influenced P_{v0} whereas age, pregnancy, and previous abdominal surgery affected the elastance, which was around 3 mm Hg per 1,000 mL IAV; the P_{v0} was around 5 mm Hg (Table 2).

PV RELATIONSHIP DURING DRAINAGE OR ADDITION OF ABDOMINAL FREE FLUID

Reed et al. retrospectively analysed 12 patients in whom it was attempted to treat IAH via puncture and drainage of intra-abdominal free fluid [44]. On assessment, the IAP ranged between 17 and 37 mm Hg. After drainage of 10 to 2,400 mL, a reduction of the IAP of up to 18 mm Hg was observed in ten patients. In two patients, no change of IAP was observed. From this data, compliance was calculated to range between 275 and 2.7 mL (mm Hg)⁻¹ (see Table 3). The PV curves that could be obtained from studies including more than three data points are shown in Figure 10.

Other studies looking at the effects of paracentesis show that C_{ab} increases as fluid is progressively removed from the abdomen. Table 4 shows changes in abdominal wall compliance (C_{ab}) during progressive paracentesis in ten patients. This data was extracted from Becker et al. [45].

In summary, measurements of C_{ab} have been performed in humans by IAP assessment with at least two corresponding IAV values by addition of abdominal fluid during peritoneal dialysis [46–53] or by drainage of intra-abdominal fluid (ascites in liver cirrhosis, peripancreatic fluid or pseudocyst, serous fluid collections in trauma or burns) [44, 54–59]. The derived mean C_{ab} during abdominal fluid shifts ranges between 23 and 1,333 mL (mm Hg)⁻¹ (Table 1). Table 1 summarises the data on IAP and IAV and their respective changes (Δ) with calculation of mean C_{ab} in a total of 523 adult patients, the mean number of patients included per study was 23 (range 4–100). The C_{ab} varies depending on the baseline IAP and whether the underlying condition is acute or chronic (this is illustrated in Fig. 11).

PV RELATIONSHIP DURING DRAINAGE OR ADDITION OF GASTRIC CONTENTS

From a theoretical point of view, addition or removal of fluids from the stomach represent also a change in IAV and the corresponding changes in IAP allow obtaining a PV relationship out of which the C_{ab} could be calculated. Gastric air insufflation can easily occur during non-invasive ventilation, oesophageal intubation or bagging during reanimation [60]. In a pig study, gastric insufflation with 5 L during

Table 1. Overview of studies examining abdominal compliance in adults

Author	Year	N	Cab method	IAP low (mm Hg)	IAP high (mm Hg)	[ΔIAP] (mm Hg)	ΔIAV range (L)	ΔIAVmax (L)	Cab low (mL [mm Hg] ⁻¹)	Cab high (mL [mm Hg] ⁻¹)	Cab mean (mL [mm Hg] ⁻¹)
Franklin [47]	1988	8	Peritoneal dialysis	3	6	3	1.00	4.00	770	3,333	1,333
McDougall [39]	1994	41	Laparoscopy	5	30	25	0.4–1.8	6.50	90	410	260
Durand [48]	1994	20	Peritoneal dialysis	8	13	5	0.51–1.18	3.00	520	850	600
Sugrue [43]	1994	9	Laparoscopy	2	14	12	4.5–13.1	8.80	563	1,092	733
de Jesus Ventura [49]	2000	42	Peritoneal dialysis male	14	17	3	0.5	1.00	320	360	333
de Jesus Ventura [49]	2000	39	Peritoneal dialysis female	13	15	3	0.5	1.00	360	520	400
Harris [51]	2001	12	Peritoneal dialysis	9	14	5	0.5	1.00	190	260	200
Scanziani [52]	2003	34	Peritoneal dialysis	9	11	2	0.16–0.43	1.00	260	640	500
Paniagua [50]	2004	13	Peritoneal dialysis	11	15	4	0.5	1.00	230	260	250
Abu-Rafea [38]	2006	100	Laparoscopy	10	30	20	0.3–1.4	3.50	60	280	175
Reed [44]	2006	4	Drainage haematoma	12	21	9	2.22	2.22	230		247
Reed [44]	2006	4	Drainage ascites burns	20	27	7	0.16	0.16	20		23
Reed [44]	2006	4	Drainage ascites non-burns	23	30	7	0.61	0.61	80		87
Dejardin [46]	2007	61	Peritoneal dialysis	6	10	4	2.00	2.00	20	520	500
Malbrain [58]	2007	5	Drainage ascites	11	20	8	0.6–4.0	2.32	20	285	280
Papavramidis [54]	2009	9	Drainage pseudocyst	5	9	4	2.31	2.31		578	550
Becker [45]	2009	10	Drainage ascites	9	18	9	0.5	4.00	192	1,000	426
Malbrain [57]	2010	4	Drainage ascites burns	11	20	10	0.2–1.6	0.68	20	177	70
Muller [4]	2010	20	Laparoscopy	7	14	7	2–4.4	3.20	286	629	457
A-Hwiesh [53]	2011	25	Peritoneal dialysis	9	16	7	2.00	2.00		290	286
Papavramidis [55]	2011	15	Drainage ascites	15	18	3	1.62	1.62		540	430
Cheatham [59]	2011	31	Drainage ascites	17	26	9	1.0–4.3	2.70	111	478	300
Horer [56]	2012	13	Drainage haematoma	16	24	8	1.52	1.52		200	190
Mean ± SD		22.7±22.8		10.6 ± 5.2	18.2 ± 7	7.6 ± 5.5		2.44 ± 2.00	240.1 ± 207.8	635.1 ± 684.6	375.2 ± 273.6
Range		4–100		2–23	6–30	2–25		0.16–8.80	20–770	177–3,333	22.9–1,333.3

Cab — abdominal compliance; IAP — intra-abdominal pressure; IAV — intra-abdominal volume

Table 2. Determinants of compliance and of pressure at zero volume

	P _{v0}	P _{v0} signif	E	E signif
Age	Neg	0.828	Pos	0.003*
Height	Neg	0.356	Neg	0.245
Weight	Pos	0.012*	Pos	0.294
BMI	Neg	0.054	Neg	0.272
Sex	Neg	0.596	Neg	0.536
Pregnancy	Neg	0.305	Neg	0.049*
Previous abdominal operation	Neg	0.191	Neg	0.009*
Muscle relaxation	Neg	0.001*	Neg	0.376

* Significance $P < 0.05$; P_{v0} — pressure at zero volume; E — elastance; BMI — body mass index

Table 3. Calculated abdominal compliance in patients with intra-abdominal hypertension*

Patient	IAP before (mm Hg)	IAP after (mm Hg)	ΔIAV (mL)	ΔIAP (mm Hg)	C _{ab} (mL [mm Hg] ⁻¹)
No. 1	19	9	2,350	-10	235.0
No. 2	17	7	2,400	-10	240.0
No. 3	25	21	250	-4	62.5
No. 4	34	14	1,300	-20	65.0
No. 5	26	26	10	0	-
No. 6	24	29	100	5	-
No. 7	17	15	550	-2	275.0
No. 8	27	19	30	-8	3.8
No. 9	37	19	50	-18	2.8
No. 10	28	19	1,800	-9	200.0
No. 11	20	11	2,330	-9	258.9
No. 12	37	26	800	-11	72.7
Mean	25.9 ± 7.2	17.9 ± 7	998 ± 987	-8.0 ± 7.1	141.6 ± 110

*IAP before and after drainage of free abdominal fluid, according to Reed et al. [44]. Compliance was calculated when consecutive pressure reduction occurred. Cases are presented in chronological order, and not in order of increasing IAP before drainage; IAV — intra-abdominal volume, IAP — intra-abdominal pressure, [ΔIAP] — absolute change in IAP

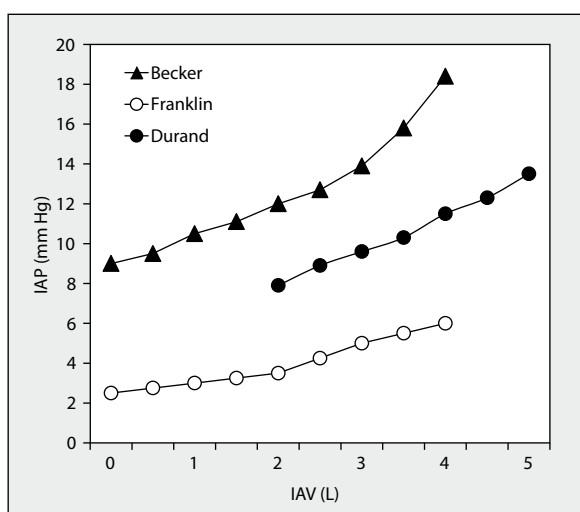

Figure 10. Abdominal pressure volume relationship during intra-abdominal fluid shifts. Relationship between intra-abdominal volume (IAV) evacuation during paracentesis [45] or IAV addition during peritoneal dialysis [47, 48] and resulting change in intra-abdominal pressure (IAP). The initial part of the abdominal compliance PV curve is linear up to pressures of 15 mm Hg and normal C_{ab} ranges between 545 mL (mm Hg)⁻¹ [48], 600 mL (mm Hg)⁻¹ [45] and 1143 mL (mm Hg)⁻¹ [47]

Table 4. Evolution of abdominal compliance (C_{ab}) during progressive ascites evacuation in ten patients

Cumulative volume evacuated (mL)	ΔIAV (mL)	$[\Delta IAP]$ (mm Hg)	C_{ab} (mL [mm Hg] ⁻¹)
500	500	2.6	192.3
1,000	500	1.9	263.2
1,500	500	1.2	416.7
2,000	500	0.7	714.3
2,500	500	0.9	555.6
3,000	500	0.6	833.3
3,500	500	1	500.0
4,000	500	0.5	1,000.0

IAV — intra-abdominal volume, IAP — intra-abdominal pressure, $[\Delta IAP]$ — absolute change in IAP. Adapted from [45, 142]

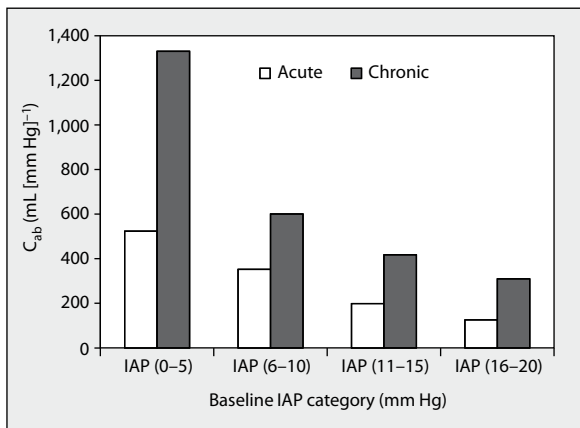

Figure 11. Abdominal compliance in relation to baseline abdominal pressure. Bar graph showing mean values of C_{ab} (mL [mm Hg]⁻¹) per baseline IAP category (mm Hg) in acute (open bars) and chronic (closed bars) conditions. Acute conditions are laparoscopy and evacuation of ascites, collections or haematomas in acutely ill patients, whereas chronic condition refers to peritoneal dialysis. Data is derived from Table 1

CPR had dramatic effects on cardiorespiratory function [61]. The same authors described a fatal case of an 18-year-old patient where excessive stomach inflation caused ACS and gut ischaemia [62]. Ileus and gastroparesis are common in critically ill patients and gastric distension can occur. Gastric aspirate volume can reach 1,000 mL per day [63]. So far no clinical studies are available.

INTERACTIONS BETWEEN DIFFERENT COMPARTMENTS
POLYCOMPARTMENT MODEL

Being linked and bound by the diaphragm, the thoracic and abdominal compartments cannot be treated in isolation. Emerson conducted numerous experiments in dogs showing that the contraction of the diaphragm is the chief factor in the rise of IAP during inspiration [64]. The respiratory system (C_{tot}) can be separated into lung (C_l) and chest wall (C_w) compliance. The chest wall consists of the thorax

with the diaphragm in parallel and the abdomen in series (Fig. 12). The applied airway pressure (P_{aw}) by mechanical ventilation will be transmitted to the lungs, pleural (P_{pl}) and abdominal spaces (IAP). The transpulmonary pressure ($TP = P_{aw} - P_{pl}$) is the distending pressure that opens alveolar units:

$$TP = P_{aw} \times C_{tot} / C_l$$

$$P_{pl} = P_{aw} \times C_{tot} / C_w$$

In a simplified model, the lung and thorax are in series and coupled to the diaphragm and abdomen in series, where C_{dia} is the compliance of the diaphragm and C_{lt} is the compliance of the lung and thorax in series (Fig. 12):

$$C_{lt} = C_l \times C_l' / (C_l + C_l')$$

$$\Delta P_{pl} = \Delta IAP \times (C_{dia} + C_{lt}) / C_{lt}$$

$$P_{dia} = IAP - P_{pl}$$

Changes in IAP are paralleled by changes in pleural pressures. Changes in thoracic compliance will be reflected by changes in abdominal compliance and vice versa; as a consequence, increased IAP will result in reduced chest wall compliance. The interactions between different compartments are referred to as the polycompartment model and syndrome [6]. For instance, transmission of airway pressures to the abdomen results from interactions between the thoracic and abdominal compartment and the percentage of pressure transmission is called the thoraco-abdominal index (TAI) of transmission (Fig. 13). This occurs in patients under positive pressure ventilation [65], application of positive end-expiratory pressure (PEEP) [66], presence of intrinsic or auto-PEEP, or a tension pneumothorax [67, 68]. Conversely, transmission of pressure from the abdomen to the thorax is called ATI and occurs in any physiologic (pregnancy) or pathologic condition associated with increased IAP; the ATI ranges from 20 to 80%, average 50% [69, 70]. The interactions are not only dependent on the specific elastance of the different components, but also on baseline pressures within the different compartments. Increased IAP has a two-sided effect: the abdominal wall is moved outwards (abdominal extension) and the gaseous contents of hollow organs within the abdominal cavity are compressed since gas is compressible while fluid is not (organ contraction). Therefore it should be noted that the abdominal compliance is also determined by the amount of gaseous contents inside the hollow organs. It seems that with constant abdominal wall elasticity, more gaseous contents results in increased abdominal compliance before the onset of increased global

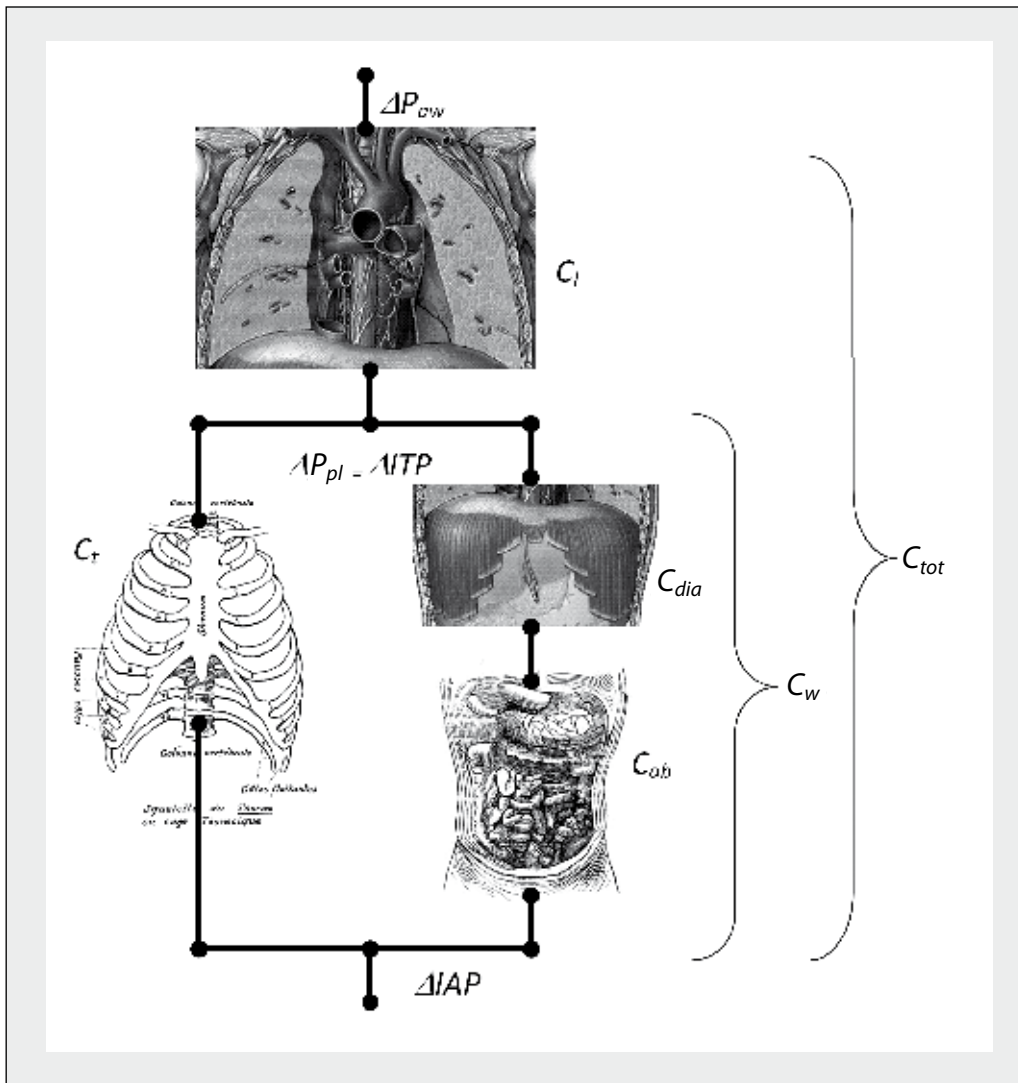

Figure 12. Interactions between different compartments. Schematic drawing with compliance separation of the different components such as lung (C_l), diaphragm (C_{dia}) and chest wall (C_w) playing a role in the transmission of pressure between thoracic (C_t) and abdominal compartments (C_{ab}) and the resultant overall compliance (C_{tot}). Based on the compliance of the different components, a certain pressure change in the lungs (ΔP_{aw}) will then be transmitted via the thorax ($\Delta P_{pl} = \Delta ITP$) to the abdomen causing a resulting change in IAP (ΔIAP). This is called the ‘thoracic abdominal index of transmission’ (TAI)

IAV. The effects of increased IAP on end-organ function are numerous: neurologic, respiratory, cardiovascular and renal adverse effects have all been described in patients with IAH and ACS [71–74]. Increased IAP leads to diminished venous return, necessitating more fluid loading, causing mesenteric vein compression and venous hypertension, finally triggering a vicious cycle.

In the following paragraphs, some experimental and potential methods will be presented to estimate C_{ab} based on the interactions between the different compartments (mainly thorax and abdomen). This can be done in mechanically ventilated patients by examination of the effects of changes in P_{aw} and tidal volume (TV) on IAP.

ESTIMATION OF ABDOMINAL COMPLIANCE DURING LOW FLOW PRESSURE VOLUME LOOP

The C_{ab} can be estimated by analysis of the dynamic changes caused by mechanical ventilation on IAP. During a low flow PV loop to determine the best PEEP one can observe the change in mean IAP (MIAP). The compliance obtained by this manoeuvre can be calculated as follows:

$$C_{abPV} = \Delta TV / \Delta MIAP$$

With ΔTV the insufflated volume and ΔIAP the difference between MIAP at the end and start of the PV loop (this is illustrated in Figs 14, 15).

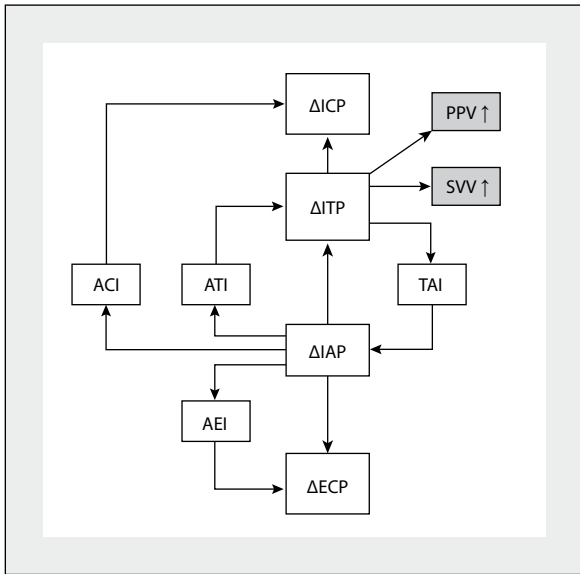

Figure 13. Changes in intra-abdominal pressure (ΔIAP) will lead to concomitant changes of pressures in other compartments. Thoraco-abdominal pressure transmission can be seen with positive pressure ventilation, PEEP or auto-PEEP, or pneumothorax. ICP — intracranial pressure; ITP — intrathoracic pressure; ECP — extremity compartment pressure; PPV — pulse pressure variation; SVV — stroke volume variation; ATI — abdomino-thoracic index of transmission; TAI — thoraco-abdominal index of transmission; ACI — abdomino-cranial index of transmission; AEI — abdomino-extremities index of transmission

ESTIMATION OF ABDOMINAL COMPLIANCE DURING MECHANICAL VENTILATION

While looking at the effects of TV excursions on IAP and by calculating the difference between IAP_{ei} and IAP_{ee} one can also obtain an idea of C_{ab} [75]:

$$C_{abTV} = TV / \Delta IAP$$

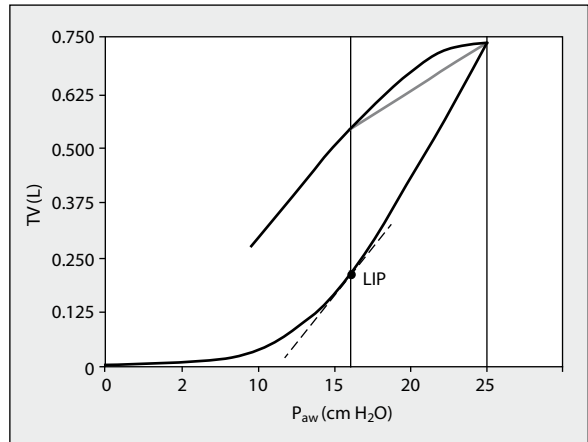

Figure 14. Estimation of abdominal compliance during low flow PV loop. Sample of a low flow respiratory PV loop with insufflation of a tidal volume of 750 mL starting from zero end-expiratory pressure (to identify best PEEP). LIP — lower inflection point; P_{aw} — airway pressure; TV — tidal volume

The higher the respiratory excursions seen in a continuous IAP tracing, the lower the C_{ab} (for the same TV). The higher the IAP, the higher ΔIAP or thus the lower C_{ab}.

CALCULATION OF ABDOMINAL PRESSURE VARIATION (APV)

The abdominal pressure variation can be calculated from a continuous IAP tracing that can be obtained from a balloon-tipped nasogastric probe (CiMON, Pulsion Medical Systems, Munich, Germany). The higher the APV for any given IAP, the lower the C_{ab}, and vice versa, the lower the C_{ab}, the higher the APV, hence APV can be used as a non-invasive and continuous estimation of C_{ab}. The APV can be calculated by dividing the ΔIAP (difference between IAP_{ei} and IAP_{ee}) with mean IAP (expressed as a percentage) as illustrated in Figure 16 [76]:

$$APV = \Delta IAP / MIAP$$

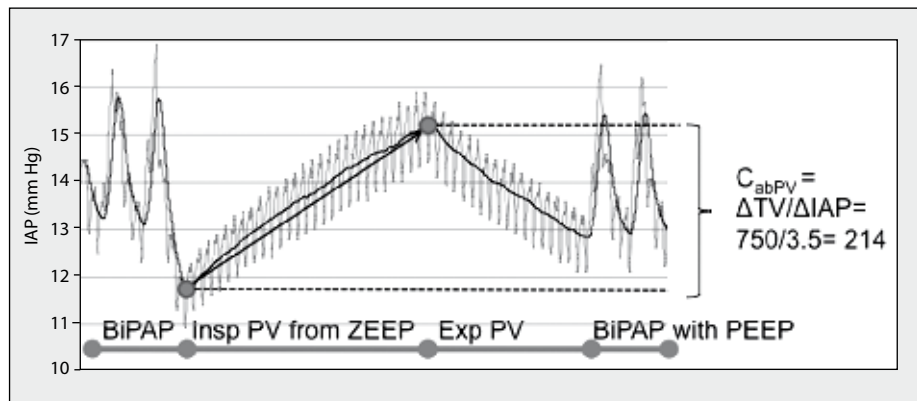

Figure 15. Estimation of abdominal compliance during low flow PV loop. The mean IAP increased from 11.7 to 15.2 mm Hg during the low flow PV loop. Hence the abdominal compliance during this manoeuvre can be estimated at 214 mL (mm Hg)⁻¹. BiPAP — bilevel positive airway pressure; Insp PV — inspiratory pressure volume curve; Exp PV — expiratory pressure volume curve; ZEEP — zero end-expiratory PEEP; TV — tidal volume; IAP — intra-abdominal pressure

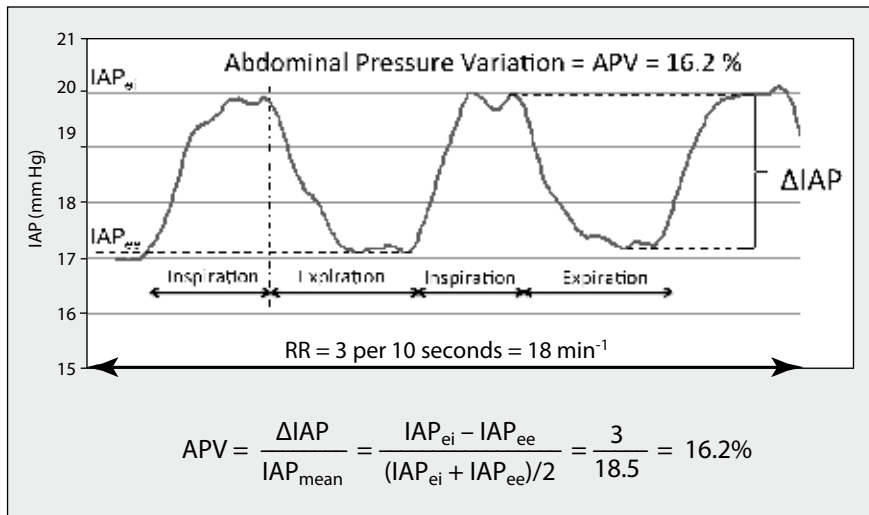

Figure 16. Estimation of abdominal compliance with abdominal pressure variation. Smoothed average of a continuous IAP tracing, excluding the pulse pressure artefacts during BiPAP ventilation with plateau pressure of 25 and PEEP of 10 cm H₂O. Mean IAP was 18.5 mm Hg with IAP = 17 mm Hg at end expiration (IAP_{ee}) and IAP = 20 mm Hg at end inspiration (IAP_{ei}), resulting in a ΔIAP (defined as IAP_{ei} - IAP_{ee}) = 3 mm Hg. The abdominal pressure variation (APV) can be calculated as ΔIAP divided by mean IAP (i.e. 3/18.5 = 16.2 %). Higher APV values for a given ventilator setting correspond to lower abdominal wall compliance. The thoraco-abdominal index (TAI) of transmission can be calculated as ΔIAP divided by (P_{plateau} minus PEEP) or thus 3/15 = 20%

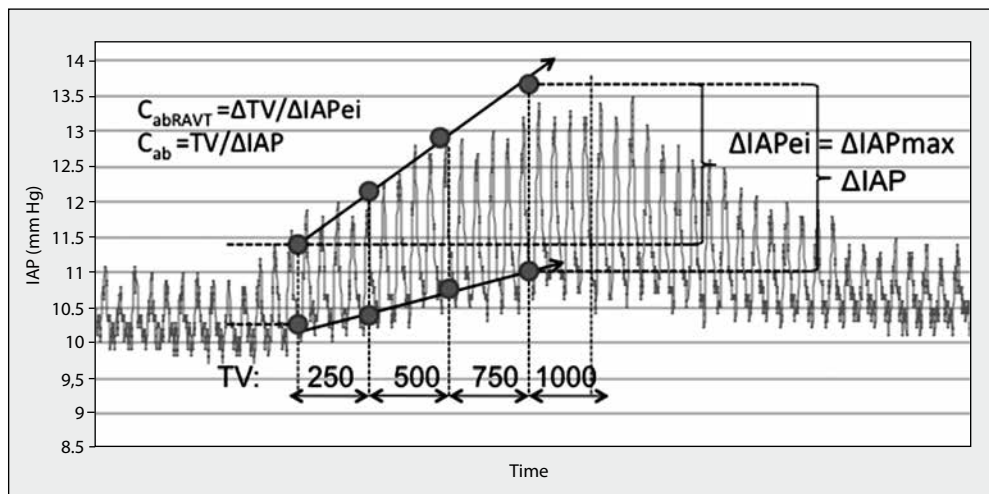

Figure 17. Estimation of abdominal compliance during the respiratory abdominal variation test (RAVT) in IPPV-mode. Smoothed average of a continuous IAP tracing (CiMON, Pulsion Medical System, Munich, Germany) obtained during the respiratory abdominal variation test (RAVT) in intermittent positive pressure ventilation (IPPV) mode. The tidal volume (TV) is stepwise increased from 250 ml to 1,000 mL with increments of 250 mL. At each TV, the following parameters were recorded: IAP_{ee}, IAP_{ei}, IAP and ΔIAP. With increasing TV mainly the IAP_{ei} increases whereas IAP_{ee} remains relatively unchanged. During RAVT, the diaphragm is displaced caudally and an additional volume is added to the abdominal cavity. The ΔIAV is probably correlated to the ΔTV observed between start and end of the RAVT (= 750 mL), the slope of the curve connecting the IAP_{ei} at each TV can be used as estimation for C_{ab}. The C_{abRAVT} in the sample presented can be calculated as follows: C_{abRAVT} = ΔTV/ΔIAP_{ei} = 750/(13.6–11.5) = 357.1 mL (mm Hg)⁻¹ and this correlates well with the C_{abTV} = TV/ΔIAP = 1000/(13.6–11) = 384.6 mL (mm Hg)⁻¹

RESPIRATORY ABDOMINAL VARIATION TEST (RAVT)

A final non-invasive method for the estimation of C_{ab} is performing a respiratory abdominal variation test (RAVT) in IPPV-mode with increasing TV (from 0 to 1,000 mL with increments of 250 mL) (Fig. 17):

$$C_{abRAVT} = \Delta TV / \Delta IAP_{ei}$$

The RAVT can also be performed in BIPAP-mode with increasing PEEP levels (from ZEEP to 15 cm H₂O) at a certain set IPAP level (Fig. 18):

$$C_{abRAVT} = \Delta TV / \Delta IAP_{ee}$$

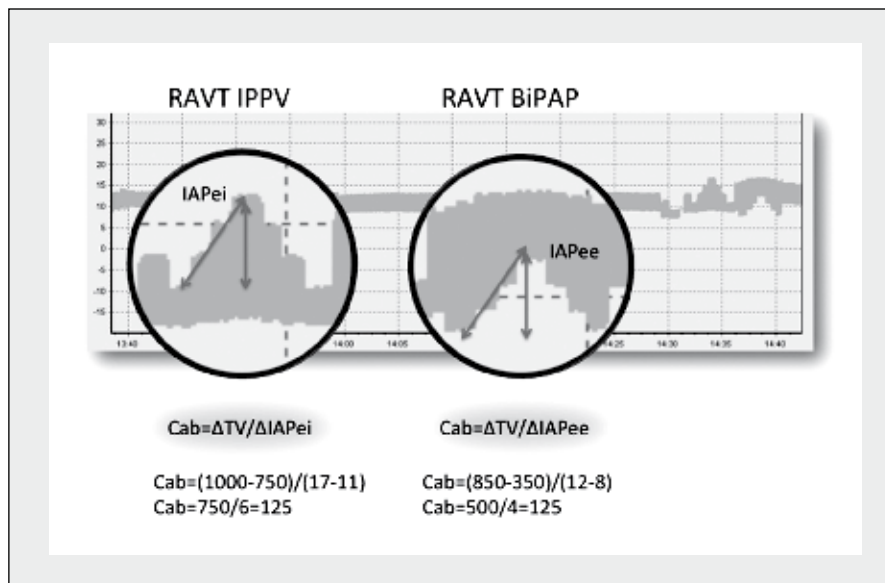

Figure 18. Comparison between two types of respiratory abdominal variation test. Continuous IAP tracing obtained with CiMON monitor (Pulsion Medical Systems, Munich, Germany) and the X-axis timescale set at 5 minutes per cm and close up views (showing 5 minute intervals). Schematic representation of the effects on IAP_{ei} and IAP_{ee} with the respiratory abdominal variation test (RAVT) in IPPV-mode (close-up circle on the left) versus BiPAP-mode (close-up circle on the right). The RAVT-IPPV results in an increase in IAP_{ei} while IAP_{ee} remains relatively unchanged. Vice versa, RAVT-BiPAP results in an increase in IAP_{ee} while IAP_{ei} remains relatively unchanged. In the sample shown, both methods allow the estimation of C_{ab} of 125 mL (mm Hg)⁻¹. See text for explanation

The C_{ab} obtained with RAVT correlates with C_{ab} obtained from ΔIAP during mechanical ventilation as illustrated in Figure 17 [77]. Increasing TV increases IAP_{ei} while increasing PEEP increases IAP_{ee}. Future studies should look at the effects of paracentesis or laparoscopy on C_{ab} and ΔIAP to confirm this hypothesis.

PROGNOSTIC AND PREDICTIVE FACTORS RELATED TO ABDOMINAL COMPLIANCE

RISK FACTORS FOR INCREASED ABDOMINAL PRESSURE

As discussed above, the measurement of C_{ab} is difficult at the bedside and can only be done in a case of change (removal or addition) in IAV. Nevertheless, the C_{ab} is one of the most neglected parameters in critically ill patients, although it plays a key role in understanding the deleterious effects of unadapted IAV on IAP and end-organ perfusion. If we can identify patients with low C_{ab} we can anticipate and select the most appropriate surgical treatment to avoid complications. Theoretically, C_{ab} allows the prediction of complications during laparoscopy and mechanical ventilation, the identification of patients who would benefit from leaving the abdomen open, the identification of patients in whom to monitor IAP, and the identification of patients at risk during prone ventilation.

Table 5 lists some common conditions related to increased IAP; in patients with one or more of these risk factors, it is suggested to estimate C_{ab} by one of the previously mentioned methods.

Table 5. Risk factors associated with increased IAP

A. Related to increased intra-abdominal contents
<ul style="list-style-type: none"> • Gastroparesis • Gastric distension • Ileus • Volvulus • Colonic pseudo-obstruction • Abdominal tumour • Retroperitoneal/abdominal wall haematoma • Enteral feeding • Intra-abdominal or retroperitoneal tumour • Damage control laparotomy
B. Related to abdominal collections of fluid, air or blood
<ul style="list-style-type: none"> • Liver dysfunction with ascites • Abdominal infection (pancreatitis, peritonitis, abscess) • Haemoperitoneum • Pneumoperitoneum • Laparoscopy with excessive inflation pressures • Major trauma • Peritoneal dialysis
C. Related to capillary leak and fluid resuscitation
<ul style="list-style-type: none"> • Acidosis* (pH below 7.2) • Hypothermia* (core temperature below 33°C) • Coagulopathy* (platelet count below 50 G L⁻¹ OR an activated partial thromboplastin time (APTT) more than two times normal OR a prothrombin time (PTT) below 50% OR an international standardised ratio (INR) more than 1.5) • Polytransfusion/trauma (> 10 units of packed red cells/24 hours) • Sepsis (as defined by the American – European Consensus Conference definitions) • Severe sepsis or bacteraemia • Septic shock • Massive fluid resuscitation (> 3 L of colloid or > 10 L of crystalloid/24 hours with capillary leak and positive fluid balance) • Major burns

*The combination of acidosis, hypothermia and coagulopathy has been termed in the literature the 'deadly triad' [143, 144]

CONDITIONS ASSOCIATED WITH DECREASED ABDOMINAL COMPLIANCE

Aside from risk factors for IAH, patients should also be screened for risk factors for decreased C_{ab} (Table 6). These can be divided into: 1) those related to body habitus and anthropomorphy (male, old age, short stature, obesity, high BMI, android fat distribution, increased visceral fat, increased waist-to-hip ratio > 1, central obesity, sphere shaped abdomen,...); 2) related to comorbidities and/or increased non-compressible IAV (capillary leak, fluid filled stomach and bowels, pleuropneumonia, tense ascites, hepatosplenomegaly, sepsis, burns, trauma and bleeding; and 3) related to abdominal wall and diaphragm (burn eschars, rectus sheath haematoma, abdominal wall haematoma, tight closure, prone and HOB positioning, Velcro belt, body builders with increased abdominal muscles and 'six-pack', umbilical

Table 6. Factors associated with decreased abdominal compliance

A. Related to anthropomorphy and demographics
<ul style="list-style-type: none"> • Male gender • Old age (loss of elastic recoil) [17] • Obesity (weight, BMI) [78–80] • Android composition (sphere, apple shape) [15, 20, 78, 79] • Increased visceral fat • Waist-to-hip ratio > 1 • Short stature
B. Related to comorbidities and/or increased non-compressible IAV
<ul style="list-style-type: none"> • Fluid overload [88] • Bowels filled with fluid • Stomach filled with fluid • Tense ascites [45] • Hepatomegaly • Splenomegaly • Abdominal fluid collections, pseudocyst, abscess • Sepsis, burns, trauma and bleeding (coagulopathy)
C. Related to abdominal wall and diaphragm
<ul style="list-style-type: none"> • Umbilical hernia repair [145, 146] • Muscle contractions (pain) [93] • Body builders (six-pack) [115] • Interstitial and anasarca oedema (skin, abdominal wall) • Abdominal burn eschars (circular) [97, 98, 147] • Thoracic burn eschars (circular) • Tight closure after abdominal surgery • Abdominal Velcro belt or adhesive drapes [148] • Prone positioning [103] • HOB > 45° [102] • Pneumoperitoneum • Pneumatic anti-shock garments • Abdominal wall bleeding • Rectus sheath haematoma [149] • Correction of large hernias • Gastroschisis • Omphalocele • Mechanical ventilation (positive pressure) [65] • Fighting with the ventilator • Use of accessory muscles • Use of positive end expiratory pressure (PEEP) [66] • Presence of auto-PEEP (tension pneumothorax) • COPD emphysema (diaphragm flattening) • Basal pleuropneumonia

hernia repair, muscle contractions due to pain, interstitial and anasarca oedema, COPD, PEEP and auto-PEEP, mechanical ventilation).

Morbidly obese patients have a higher baseline IAP, around 12–14 mm Hg, and this is mainly related to the presence of central obesity [15, 78–81]. As discussed above, morbidly obese patients with an android (mainly visceral and sphere shaped) fat distribution have a limited reserve to accommodate more IAV than the baseline IAV compared to those patients who for the same BMI or abdominal perimeter have a gynoid (mainly subcutaneous and ellipse shaped) fat distribution [15, 78]. On the other hand, if subcutaneous fat accumulates, this may have a negative effect on the elastic properties of the abdominal wall although the thin muscle layer may have a beneficial effect. Therefore it is not possible to predict C_{ab} in obese patients. In general, C_{ab} is decreased because of the increased baseline IAV resulting in decreased reshaping capacity and abdominal wall compliance and the gravitational effects of the extra weight causing an increased baseline IAP. As such, it may be advisable to consider weight loss before elective laparoscopic surgery.

CONDITIONS ASSOCIATED WITH INCREASED ABDOMINAL COMPLIANCE

Table 7 lists some conditions associated with improved C_{ab} . These can also be divided into: 1) those related to body habitus and anthropomorphy (young age, lean and slim body composition, normal BMI, tall height, gynoid fat distribution, preferentially subcutaneous fat, waist-to-hip ratio < 0.8, peripheral obesity, ellipse or pear-shaped abdomen); 2) absence of comorbidities and/or increased compressible IAV (air filled stomach and bowels, normothermia, normal coagulation, normal pH); and 3) related to abdominal wall and diaphragm (burn escharotomy, avoidance of tight closure, open abdomen with temporary abdominal closure, beach chair positioning, muscle relaxation, pain control, sedation and analgesia, bronchodilation, lung protective ventilation, previous pregnancy, previous laparoscopy, previous abdominal surgery, large hernias before repair).

Previous stretching of the abdominal fascia increases C_{ab} ; this can be explained by a gradual pre-stretching of the internal abdominal cavity perimeter during acute or progressive increased IAV (as is the case during laparoscopy, with pregnancy, peritoneal dialysis, cirrhotic ascites) [16, 29, 40, 45, 82]. An animal study showed that even a short period of pre-stretching (20 minutes) is sufficient to increase C_{ab} [29]. This was also shown in patients undergoing laparoscopic surgery where a gradual increase in workspace IAV was observed when insufflation pressures were maintained at target levels [82]. The authors found a correlation between the duration of the pre-stretching period and the beneficial effects on C_{ab} . In summary, pre-stretching (either acute as

Table 7. Factors associated with increased abdominal compliance

A. Related to anthropomorphy and demographics
<ul style="list-style-type: none"> • Height (tall stature) • Young age • Female gender • Lean and slim body • Normal BMI • Gynoid composition (ellipse, pear-shaped)[20] • Waist-to-hip ratio < 0.8 • Peripheral obesity • Preferentially subcutaneous fat
B. Related to absence of comorbidities and/or increased compressible IAV
<ul style="list-style-type: none"> • Bowels filled with air • Stomach filled with air • Absence of deadly triad: normothermia, normal pH, normal coagulation
C. Related to abdominal wall and diaphragm
<ul style="list-style-type: none"> • Umbilical hernia (before repair) [145] • Burn escharotomy (thorax and/or abdomen) • Avoidance of tight closure • Open abdomen with temporary abdominal closure • Beach chair positioning • Sedation and analgesia • Muscle relaxation • Bronchodilation • Lung protective ventilation • Pre-stretching of fascia (cirrhosis with ascites, peritoneal dialysis when fluid is drained from abdomen) [29] • Previous pregnancy [16] • Previous laparoscopy [40, 82] • Previous abdominal surgery [150] • Abdominal wall lift [151] • Weight loss

during laparoscopy or chronic as in pregnancy, peritoneal dialysis, ascites, ovarian tumour) results in the same baseline IAV, a decreased baseline IAP, and abdominal wall compliance and an increased reshaping capacity. In these conditions, abdominal workspace may be sufficient.

Patients with a previous history of laparotomy, laparoscopy or multiple pregnancies had greater C_{ab} at the beginning of the procedure; however, they showed a smaller increase in C_{ab} during the procedure confirming the increased reshaping capability (or the possibility to accommodate a larger IAV for the same pressure during a subsequent procedure) but decreased compliance of the abdominal wall [16, 82]. Pre-stretching or overdistension may indeed result in tissue damage and fibrosis of the abdominal wall structure with lengthened muscle fibres and diminished elastic retraction capacity. History of a previous laparotomy may lead to scarring of the abdominal wall, which in combination with adhesions can cause decreased elasticity [82]. The C_{ab} may be decreased or increased and the effect of previous laparotomy on baseline IAV and IAP are unpredictable as such laparoscopic workspace may be limited.

The use of external bandages (drapings, Velcro belt) or tight surgical closures causes a mechanical limitation,

and as a result baseline IAP will increase while IAV, reshaping capacity, and abdominal wall compliance will all be decreased. The use of Velcro belts and tight closures hence should be avoided in high-risk patients and IAP should be measured during their use. The same principles hold true in athletes or body builders with strong and thick abdominal muscles with reduced ability to distend (six-pack). In those patients, the laparoscopic abdominal workspace volume may be limited and they are at risk for IAH when admitted to ICU. The use of positive pressure mechanical ventilation will increase IAP and decrease reshaping capacity while IAV and wall compliance usually remain constant. In a case of capillary leak, fluid overload and fluid collections, both IAV and IAP will increase while reshaping capacity and wall compliance both will decrease.

TREATMENT

In this section, we will discuss possible therapeutic options that will either result in an increase in C_{ab} , a decrease in baseline IAP or IAV, or a combination of effects.

HOW TO DECREASE BASELINE IAP?

In simple terms, in order to reduce IAP, either (additional) IAV has to be removed (e.g. weight loss, fluid removal via dialysis with net ultrafiltration, ascites drainage, gastric suctioning, evacuation of abscess or haematoma) or the C_{ab} has to be improved by increasing the internal abdominal cavity perimeter and surface area (pre-stretching, open abdomen treatment). Losing weight and the resulting drop in BMI will decrease IAP [83]. Studies during laparoscopy have shown that muscle relaxants decrease opening pressures (P_{vo}) or thus baseline IAP [16]. For other specific treatment options to reduce IAP in the setting of IAH, we refer to other publications [1, 84–86].

HOW TO REDUCE IAV?

The evacuation of intra-luminal and intra-abdominal contents will decrease the IAV [1, 84–86]. This can be done via placement of a nasogastric tube with suctioning either or not in conjunction with gastroprokinetics (cisapride, metoclopramide or erythromycin). Paracentesis with evacuation of ascites and the placement of a rectal tube in conjunction with enemas and colonoprokinetics (prostagin) may also reduce IAV [59]. Colonic pseudo-obstruction or Ogilvie's syndrome may be treated with endoscopic decompression of large bowel or a surgical colostomy or ileostomy together with colonoprokinetics [87]. When in doubt, imaging should be performed and an ultrasound or CT guided drainage should be attempted in a case of haematoma, abscess, or fluid collections. The correction of capillary leak and avoiding a positive fluid balance will also eventually lead to a decreased IAV by decreasing organ and bowel

oedema [88]. This can be achieved with (hypertonic) albumin in combination with diuretics (furosemide), correction of capillary leak (antibiotics, source control), the use of colloids instead of crystalloids and eventually dialysis or CVVH (continuous venovenous hemofiltration) with ultrafiltration [89]. Targeted APP (abdominal perfusion pressure) with the use of vasopressors will reduce IAV (analogous to the effect of norepinephrine on ICP [intra cranial pressure] and CPP [cerebral perfusion pressure]), and dobutamine (but not dopamine) will improve splanchnic perfusion [90, 91]. Ascorbic acid has been associated with reduced incidence of secondary ACS in burn patients [92].

HOW TO IMPROVE C_{AB} ?

The improvement of C_{ab} should be performed in a stepwise approach as suggested by the WSACS consensus recommendations.

FIRST STEP: ENSURE ADEQUATE SEDATION AND ANALGESIA

Fentanyl should not be used as it may increase abdominal muscle tone while dexmedetomidine has superior effects over propofol [93, 94]. Thoracic epidural anaesthesia, on the other hand, has been shown to reduce IAP via increase in C_{ab} [95].

SECOND STEP: REMOVE CONSTRICTIVE BANDAGES AND ESCHARS

Any tight abdominal closure like a Velcro belt to prevent incisional hernia related to postoperative coughing or a 'ventre au fils de fer' (the iron belly) in a patient with abdominal hypertension and end-organ dysfunction (e.g. respiratory insufficiency) should be removed immediately [96]. Likewise escharotomies (abdominal but also thoracic) will increase C_{ab} while sternotomy will increase not only thoracic wall compliance but also C_{ab} [97–99]. Placing a chest tube in a case of a tension pneumothorax or pleural effusion will increase C_{ab} as well [100].

THIRD STEP: AVOID PRONE AND HEAD OF BED > 30° AND CONSIDER REVERSE TRENDLENBURG POSITION

Body positioning such as the Trendelenburg position can lower bladder pressure although it may compromise respiratory function [78]. The use of HOB elevation above 30° can on the other hand increase bladder pressure [78, 101, 102]. The HOB 45° position will increase IAP with 5 to 15 mm Hg [78]. A case has been described where HOB 45° led to cardiorespiratory collapse in a patient on non-invasive mechanical ventilation [60]. Therefore in patients with respiratory insufficiency that are mechanically ventilated, the anti-Trendelenburg position may be the best to allow lung recruitment, oxygenation and ventilation [7]. The use of special skin pressure-decreasing interfaces with the use of

an air cushioned mattress rather than a foam mattress will avoid decrease of C_{ab} especially when proning the patient [103, 104]. During prone positioning ventilation, there is a merit in unloading the abdomen (abdominal suspension) as this will result in a decrease in chest wall compliance, while the effect of gravity will improve C_{ab} and decrease IAP, forcing the tidal volume to go to the dorsobasal (collapsed) regions of the lung [103]. During laparoscopy, the body position can also help to optimise the laparoscopic workspace IAV. The Trendelenburg position with HOB 20° provides the optimal workspace in lower abdominal laparoscopic surgery, while this is the beach-chair position (flexing the legs in reverse Trendelenburg) during upper abdominal laparoscopic surgery in obese patients [4]. Laparoscopic insufflation pressures should at all times be limited to 15 mm Hg. If workspace IAV is too small, pressures above 15 mm Hg can be used for a limited time and under close monitoring of cardiorespiratory function. Higher working pressures cannot be routinely recommended in obese patients with high baseline IAP. In morbidly obese patients, open surgery seems the best option because of the high complication risk associated with pneumoperitoneum [80]. The same holds true for laparoscopy in patients with intracranial hypertension.

FOURTH STEP: LOSE WEIGHT AND AVOID FLUID OVERLOAD

Similarly to weight loss, avoiding a positive cumulative fluid balance and obtaining a negative fluid balance with the use of diuretics [105] either or not in combination with hypertonic solutions (albumin 20%) [89] will decrease interstitial oedema of the abdominal wall and increase C_{ab} . Fluid resuscitation should be guided by volumetric (and not barometric) preload indicators, and if CVP is used transmural pressures should be calculated [6, 106, 107]:

$$CVP_{tm} = CVP_{ee} - IAP/2$$

In case diuretics alone don't have sufficient effect, renal replacement therapy with haemodialysis or CVVH can be used [108–110].

FIFTH STEP: USE NEUROMUSCULAR BLOCKERS

Theoretically, the use of neuromuscular blockade should not only lower baseline IAP but also improve C_{ab} [111–114]. However, no additional increase in C_{ab} has been shown after full block of abdominal muscle contractions (guided by train of four testing) [16, 115].

SIXTH STEP: CONSIDER LESS INVASIVE SURGERY

Recently, a less invasive percutaneous endoscopic abdominal wall component separation (EACS) technique has been described [116]. With this technique, the abdominal capacity (maximal stretched volume) increased by 1 L while

IAP decreased from 15.9 ± 2.1 to 11 ± 1.5 mm Hg ($P < 0.001$) [116]. Another alternative to midline laparotomy is subcutaneous linea alba fasciotomy (SLAF) which seems a promising approach especially in secondary IAH and ACS [117].

A HOLISTIC INTEGRATED APPROACH

Integrating all the above knowledge on IAP, IAV, and C_{ab} , one could imagine the development of a theoretical model or even a device that could increase C_{ab} or decrease IAP and IAV [118–120]. The application of a bell or shell on the abdomen has been studied previously in animals and humans [121–125]. For this modelling, we assume that the membrane of the abdomen responds to the linearity of Young [126]. This means that a variation in the IAV implies a proportional variation in the IAP exerted by the membrane or thus:

$$\kappa \times \Delta V = \Delta P$$

Where κ is the constant elastance of the abdomen, or alternatively

$$IAP_2 = IAP_1 - P_{atm} + P_{vac} + \kappa \times IAV_2 - IAV_1 \quad (1)$$

$$IAP_1 \times IAV_1 \times X_1 = IAP_2 \times IAV_2 \times X_2 \quad (2)$$

Where IAP_1 represents the IAP before the application of the negative pressure expressed in mm Hg, P_{atm} is the atmospheric pressure, P_{vac} is the pressure within the abdominal bell, IAV_1 is the initial volume of the abdomen prior to the use of the bell in m^3 , IAV_2 is the volume of the abdomen after applying the negative pressure, X_1 is the relation of air volume versus total volume 1 and 2 or thus the initial percentage of air in the abdomen. At this point, the parameters X_2 , IAV_2 and IAP_2 are unknown. Since water is not compressible, we can calculate X_2 :

$$V_{water1} = V_{water2} = IAV_1 - IAV_1 \times X_1 \quad (3a)$$

$$X_2 = 1 - V_{water}/IAV_2 = 1 - (IAV_1 - IAV_1 \times X_1)/IAV_2 \quad (3b)$$

Replacing (3b) in (2) the following can be deduced:

$$IAV_2 = IAV_1 - IAV_1 \times X_1 + IAV_1 \times X_1 \times IAP_1/IAP_2 \quad (4)$$

From (1) and (4) the following relation can be derived:

$$IAP_2 = IAP_1 - P_{atm} + P_{vac} + \kappa \times X_1 \times IAV_1 \times (IAP_1/IAP_2 - 1) \quad (5a)$$

$$IAP_2^2 - (IAP_1 - P_{atm} + P_{vac} - \kappa \times X_1 \times IAV_1) \times IAP_2 - \kappa \times X_1 \times IAV_1 \times IAP_1 = 0 \quad (5b)$$

the unknown IAP_2 can then be calculated as follows (6):

$$\frac{(IAP_1 - P_{atm} + P_{vac} - \kappa \times X_1 \times IAV_1) \pm \sqrt{(IAP_1 - P_{atm} + P_{vac} - \kappa \times X_1 \times IAV_1)^2 + 4\kappa \times X_1 \times IAV_1 \times IAP_1}}{2}$$

By means of a simple software program in Excel (Microsoft Corporation, USA) this function can be used to simulate the final IAP based on the pressure in the bell by simulating the different parameters. This is illustrated in Figure 19 and confirms the linear behaviour of the model.

Recently a non-invasive device called ABDOPRE (short for ABDOMinal PREssure) was developed to reduce IAP (Fig. 20) [119]. The device consists of a Plexiglas® bell placed air-tightly on the patient’s abdomen, resting on the bones framing the abdomen. The bell is connected to a vacuum pump. Negative pressure in the bell (P_{vac}) lifts the abdominal wall, i.e. it increases IAV thereby reducing IAP.

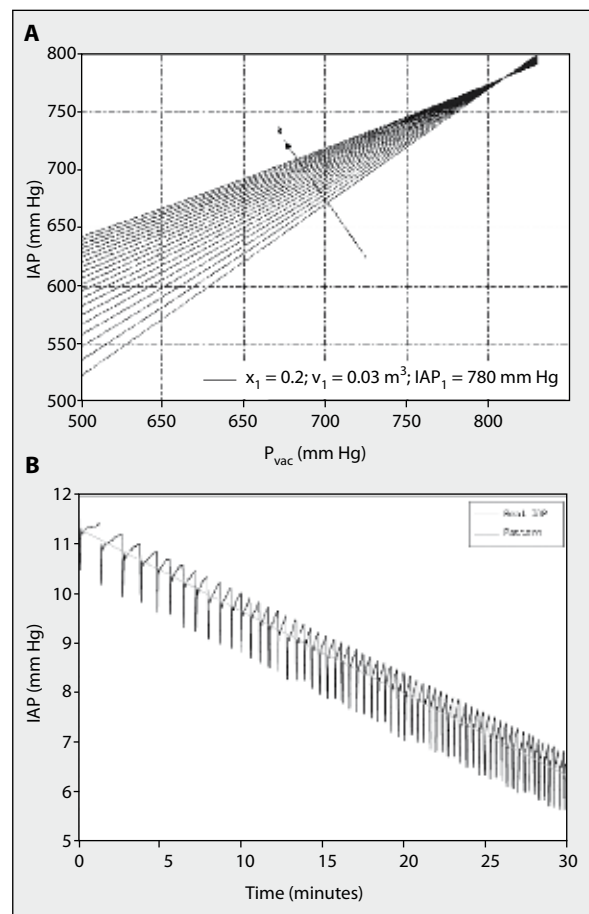

Figure 19. Supposed linear relation between abdominal and negative external pressure; **A** — schematic drawing of the evolution of IAP in relation to the pressure in the bell (P_{vac}), while changing the elastance of the abdomen (κ) Adapted from David et al. [120]; **B** — reduction of IAP (mm Hg) over time in an experimental phantom model. The phantom’s shape fitted the vacuum bell. This design allowed analysis of compressible object behaviour similar to real life. Adapted from David et al. [120]

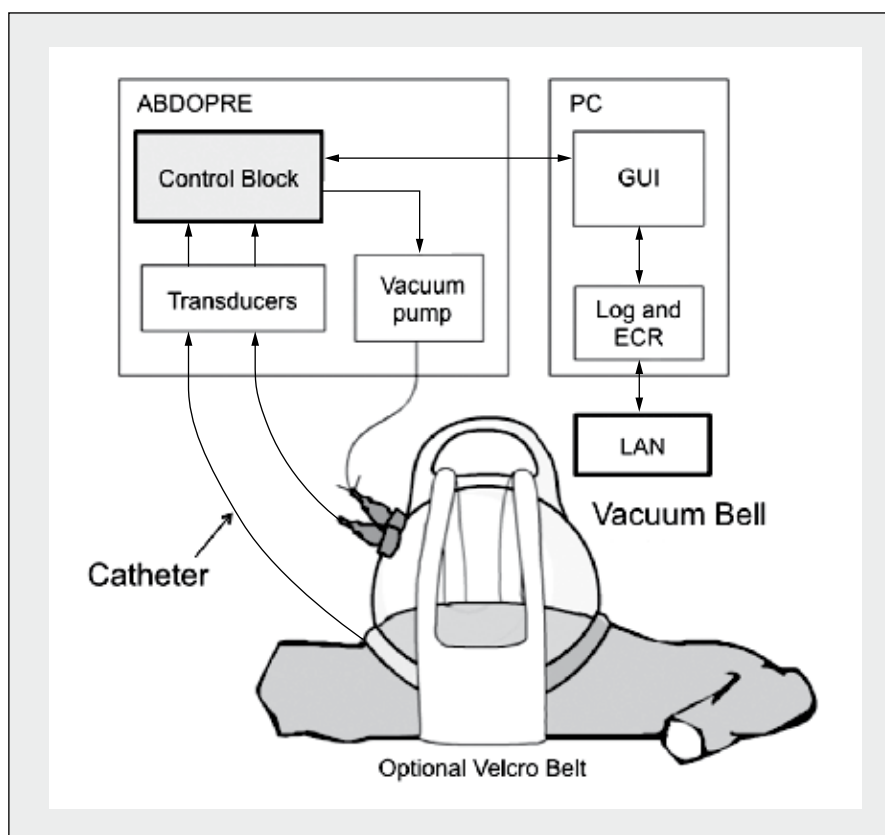

Figure 20. Schematic drawing of the ABDOPRE system. The system has four functional blocks: a vacuum chamber, a signal acquisition part, a control part, and a user interface, including a graphic user interface (GUI) and an electronic clinical record (ECR), connected to a local area network (LAN). Adapted from David et al. [119]

$$\Delta IAP = C_{ab} \times \Delta P_{vac}$$

The ABDOPRE allows different treatment protocols to be adopted for different patients, by setting the following parameters: 1) Desired value for IAP; 2) IAP tolerance (e.g. 0.4 mm Hg); 3) Duration of treatment (in minutes); and 4) End of treatment instructions (restart, change protocol or stop). The ABDOPRE displays and graphs IAP and its set value. At the end of each treatment a document is created for the patient's records. A preliminary study in four patients showed that three of the four responded to the application of external negative pressure, and in those the IAP decreased from 12.7 to 9.3 mm Hg [118] (Fig. 21). The specificity of ABDOPRE is, as preliminary clinical work has shown, that a servo-controlled reduction in IAP can be achieved. The exact protocol of pressure lowering and relaxation however is still to be defined. What is clear is that, far from being an adaptation of an external respiratory assisted device, ABDOPRE specifically addresses the problems related to IAH and ACS.

This will lead to future options for non-invasive treatment and regulation of IAP and IAV with the use of negative extra-abdominal pressure (NEXAP) as illustrated in Figure 22.

However, when all the above listed treatment options fail to provide a sufficient decrease in IAP and IAV, the only definite solution is to perform a decompressive laparotomy that will have beneficial effects on IAP, IAV and C_{ab} [127].

DISCUSSION

Based on the foregoing, we can state that with regard to the measurement principles of IAP, IAV and C_{ab} in the clinical situation, a number of questions and issues still need to be addressed:

- Is the abdominal compartment linked to the diaphragm and thorax in series or in parallel? The abdominal compartment is linked in series to the diaphragm and in parallel to the chest wall.
- Why is C_{ab} not affected by neuromuscular blockers? The C_{ab} does not change with muscle relaxation, since this only has an effect on the resting pressure (P_{v0}) and not the C or E [16, 112, 128].
- Can the C_{ab} be modulated by other medications or interventions? As stated above, the most important factors reducing C_{ab} will either be caused by internal accumulation of fluid or external compression in burn eschars or via tight closure or use of a Velcro belt. Theoretically, the

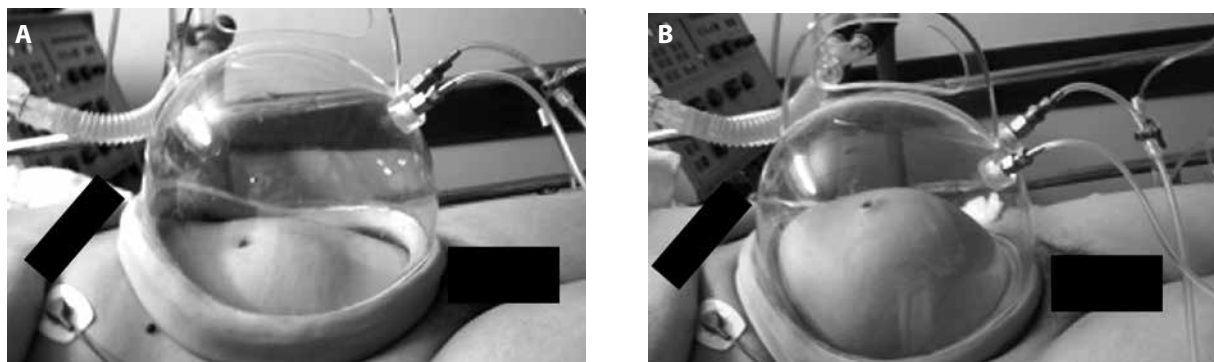

Figure 21. ABDOPRE applied to a patient; **A** — fitting of the bell onto the patient's abdomen, the initial Intra-Abdominal Pressure (IAP) was 14 mm Hg. Adapted from David et al. [119]; **B** — the abdomen is lifted when negative pressure is applied in the bell and IAP decreased from 14 to 9 mm Hg

application of an external negative pressure device may increase the space for a given IAV and as such may lower IAP [118]. Leg flexion increases the compliance while table inclination (anti-Trendelenburg or HOB) changes only the P_{v0} [4]. Furthermore, body and external temperature will exert an effect on C_{ab} (e.g. shivering) and finally abdominal wall perfusion will also affect C_{ab} ; early pig experiments showed that when perfusion pressure dropped too much with inhalation anaesthetics, the abdomens were stiffer. A possible explanation may be that although inhalation anaesthetics seem to affect only the P_{v0} like muscle relaxants but not the C_{ab} , the sudden hypotension may result in vasomotor tone changes that negatively affect the C_{ab} . The use of epidural anaesthesia has been shown to exert beneficial effects on C_{ab} [95].

- What is the best technique to measure IAP or C_{ab} ? The gold standard measurement technique for IAP estimation remains the bladder. To date there is no good technique to measure IAV at the bedside, while the C_{ab} can be measured very accurately and simply during laparoscopy. New less invasive techniques to estimate C_{ab} are based on the interactions between the thorax and the abdomen in patients under positive pressure ventilation. An unanswered question is whether or not it will be possible to calculate volume ratios of the different organs in relation to the total abdomen volume at the bedside. In this respect, electric impedance tomography of the abdomen may be helpful in the future [35].
- Can we measure IAV at the bedside? Not yet, but body anthropomorphy offers useful information at the bedside.
- Can we measure C_{ab} at the bedside or only via laparoscopy? In the ICU, the continuous measurement of IAP allows us to determine the respiratory variations in the IAP tracing and this offers useful alternatives to estimate C_{ab} (e.g. via low flow PV loop or RAVT) [77].
- In which patients should IAP, IAV or C_{ab} be measured? Routine IAP measurement in all patients admitted to

the ICU is not indicated. The WSACS has provided a list with risk factors associated with IAH and ACS (Table 5); in patients presenting with two or more of these risk factors, IAP monitoring is advocated [1]. Of course, even when, in the absence of these risk factors, IAH is suspected, IAP monitoring should be initiated.

- What is the best frequency for IAP monitoring? When an intermittent method is used, measurements should be obtained at least every 4–6 hours, and in patients with evolving organ dysfunction, this frequency should be increased to hourly [12, 129]. In patients who are on the steep part of the compliance curve, IAP should be measured more frequently, as small changes in IAV may have significant effects on IAP. Also, it may be considered extremely prudent to add additional volume to the abdominal compartment, e.g. enteral nutrition. Those patients (i.e. with high baseline IAP values, after massive fluid resuscitation, or abdominal burns) should be considered candidates for nasogastric suctioning in combination with all other noninvasive options to lower IAV and thus also IAP.
- When to stop IAP measurement? IAP measurement can be discontinued when the patient has no signs of acute organ dysfunction, and IAP values have been decreased below 10 mm Hg for 24–48 hours. In case of recurrent organ dysfunction, IAP measurement should be reconsidered.
- What about IAP in children? When using the bladder, smaller instillation volumes should be used (1 mL kg^{-1} with a maximum of 20 mL). Children also have lower IAP values and the thresholds for IAH and ACS are lower, around 10 to 12 mm Hg respectively [1, 130].
- What about the effect of body position on IAP, IAV or C_{ab} ? When measured in the head of the bed (HOB) elevated to 30° and 45°, the IAP on average is respectively 4 and 9 mm Hg higher [131]. This effect is more pronounced in patients with higher BMI [7]. If we accept that the abdomen behaves as a hydraulic system, then the descent of



Figure 22. Examples of practical and bedside external application devices to lower IAP and/or IAV; **A** — The ABDOPRE, a device that can be used for lowering IAP by using a bell [118]; **B** — The bell to be applied on the abdomen in which a negative pressure or vacuum can be generated [120]; **C** — the application of NEXAP on the abdomen in an animal study [124]; **D** — The so-called sarcophage, a medical device that can generate continuous NEXAP, in which a patient is placed in toto [152]; **E** — cuirass placed on the abdomen in a patient [122]; **F** — the application of a cuirass placed upside down on the abdomen, normally to be put on the thorax for negative pressure ventilation [125]

intra-abdominal contents by HOB elevation may exert external pressure on the bladder, leading to an increase of intravesicular pressure. On the other hand, when the patient is in the semirecumbent position, a compression of the abdomen between the pelvis and the ribcage is likely. This may have a profound effect on IAP if the patient is on the steep part of the PV curve.

— What about the effect of instillation volume on IAP when measured via the bladder? In the early days of IAP measurement, instillation volumes as high as 250 mL were used [132]. Several studies in critically ill patients have demonstrated that high volumes (above 25 mL) may falsely elevate IAP — probably due to increased detrusor tension [133]. Also, 10–20 mL proved to be

- enough for reliable IAP measurement [134]. For children, it can be assumed that the same principles apply. For adults, the recommended instillation volume is 25 mL at most; for children as stated above it is 1 mL kg⁻¹ up to a maximum of 20 mL.
- What about the effect of instillation temperature on IAP when measured via the bladder? Low (i.e. room) temperature of the instillation fluid may erroneously increase IAP readings as the bladder detrusor muscle may contract and decrease bladder wall compliance [135]. When the instillation volume is low, this effect is assumed to be minimal.
 - Is the equilibration time important during IAP measurement via the bladder? For a good IAP measurement, one should wait for equilibration of the pressure signal for at least 30 to 60 seconds [135].
 - What about IAP measurements in awake patients? It is believed that awake patients may have higher resting/baseline values due to abdominal muscle tone [12].
 - Does bladder compliance change over time? Bladder compliance is different from abdominal compliance. It is not linear at all, and is probably also related to fluid balance (e.g. presence of ascites exerting a compressive force on the bladder). Bladder filling status prior to bladder pressure measurement may also play a role [136].
 - How do different intravisceral pressures relate to each other? So far, little data is available regarding simultaneous bladder, stomach and rectal pressure measurements. But within the abdomen alone, different compartments may exist [137, 138]. It is not clear what the role of therapeutic options like decapsulotomy (kidneys) is versus open abdomen with temporary abdominal closure, neither do we have information on the measurement of selective organ volumes and pressures.
 - Is the absolute IAP or IAV value important or is the trend (Δ) more relevant? The evolution over time is probably more relevant than one single value. With the advent of continuous IAP, the area under the curve for a certain threshold, as well as the time above a certain threshold for each 24 hour period, can be examined in the future and this may be related to morbidity and mortality [139].
 - Can we measure IAV continuously? Yes, theoretically this is possible with a gas diffusion technique during laparoscopy.
 - What is the best way to measure IAP continuously? From a theoretical point of view, continuous bladder pressure measurement is not possible in a patient who passes urine since drainage and measurement cannot be combined. With a special three-way Foley this could be overcome although there still may be some methodological issues [7]. Therefore, as of today, continuous stomach pressure with a balloon tipped nasogastric

tube seems the best option [9, 11, 45]. Another possibility could be via a balloon-tipped abdominal drain. In the near future, nasojejunal feeding tubes with gastric balloons and two and three balloon catheters with oesophageal, stomach and position balloon will become available [140].

- Should we always measure intrathoracic volume as well? The excursions in tidal volume can act as a surrogate for changes in intrathoracic volume and can help us to quantify C_{ab} .
- Is the IAV independent of IAP or abdominal compliance? Yes and no; in other words, depending on C_{ab} for the same IAV, the resulting IAP can be different.
- The key question however is not only to determine what the abdominal compliance curve looks like, but more importantly where the patient is on the compliance curve and whether or not decompression is needed. Moreover, C_{ab} is a dynamic value, not fixed because of the elastance that may change over time during the disease process. In this respect, fluid management plays a crucial role and over-resuscitation and fluid overload should be avoided by all means possible [141].

CONCLUSIONS

The C_{ab} is one of the most neglected clinical parameters and plays a key role in understanding the deleterious effects of unadapted IAV on IAP and end-organ perfusion and function. Estimation or measurement of C_{ab} is difficult, but some promising techniques are readily available at the bedside. Abdominal compliance is defined as a measure of the ease of abdominal expansion, which is determined by the elasticity of the abdominal wall and diaphragm [2]. It should be expressed as the change in intra-abdominal volume (IAV) per change in IAP, expressed as mL (mm Hg)⁻¹. The C_{ab} can be estimated based on demographic and anthropomorphic data and can be assessed by PV relationship analysis of the observed changes in IAP mirroring induced changes in IAV, either by addition (laparoscopy, peritoneal dialysis, gastric insufflation) or removal (pseudocyst or haematoma drainage, ascites paracentesis, gastric suctioning) of IAV. The abdominal PV relation is believed to be linear up to pressures of 12 to 15 mm Hg and increases exponentially afterwards. The abdominal compliance can also be estimated noninvasively by examining the interactions between pressure variations in the thorax and abdominal compartment during positive pressure ventilation based on the principles of the polycompartment model and the transmission of pressures between compartments. If we can identify patients with increased (previous pregnancy or laparoscopy, gynoid fat distribution, ellipse-shaped internal abdominal cavity perimeter) or decreased (obesity, fluid overload, android fat distribution, sphere-shaped internal abdominal perimeter) C_{ab} we can anticipate and select the

most appropriate medical and surgical treatment to avoid complications like IAH or ACS.

A large overlap exists between the treatment of patients with abdominal hypertension and those with low C_{ab} . Treatment of patients with low C_{ab} is based on six principles. The ICU physician should have the following approach: 1) ensure adequate sedation and analgesia; 2) remove constrictive bandages and eschars; 3) avoid prone and head of bed > 30° and consider reverse Trendelenburg position; 4) reduce patient weight and avoid fluid overload; 5) use neuromuscular blockers; and finally, 6) consider less invasive surgery such as EACS or SLAF.

ACKNOWLEDGEMENTS

Dr Derek Roberts is supported by an Alberta Innovates – Health Solutions Clinician Fellowship Award, a Knowledge Translation Canada Strategic Training in Health Research Fellowship, and funding from the Canadian Institutes of Health Research.

Dr Bart De Keulenaer is the chairman of the WSACS CTWG (Clinical Trials Working Group).

Dr Inneke De laet is Secretary of the WSACS executive and Dr Jan De Waele is the current President.

Dr Manu Malbrain is founding President of WSACS and current Treasurer. He is a member of the medical advisory board of Pulsion Medical Systems, a monitoring company, and consults for KCI, ConvaTec and Holtech Medical.

Dr Alexander Schachtrupp is lecturer at the Department of Surgery, Technical University of Aachen, and head of the Department of Medical Science, B.Braun Melsungen. B.Braun does not distribute products specially designed for prevention, diagnosis or therapy of IAH or ACS.

The other authors have no possible conflicts of interest related to the content of this review paper.

References:

1. Kirkpatrick AW, Roberts DJ, De Waele J et al.: Intra-abdominal hypertension and the abdominal compartment syndrome: updated consensus definitions and clinical practice guidelines from the World Society of the Abdominal Compartment Syndrome. *Intensive Care Med* 2013; 39: 1190–206.
2. Malbrain MLNG, Roberts DJ, De laet I et al.: The role of abdominal compliance, the neglected parameter in critically ill patients — a consensus review of 16. Part 1: Definitions and pathophysiology. *Anaesthesiol Intensive Ther.* 2014; 46: 392–405.
3. Holodinsky JK, Roberts DJ, Ball CG et al.: Risk factors for intra-abdominal hypertension and abdominal compartment syndrome among adult intensive care unit patients: a systematic review and meta-analysis. *Critical Care* (London, England). 2013; 17: R249.
4. Mulier JP, Dillemans B, Van Cauwenberge S: Impact of the patient's body position on the intraabdominal workspace during laparoscopic surgery. *Surg Endoscop* 2010; 24: 1398–1402.
5. Kuehnappel UG, Neisius B: CAD-based graphical computer simulation in endoscopic surgery. *Endosc Surgery Allied Technol* 1993; 1: 181–184.
6. Malbrain ML, Wilmer A: The polycapartment syndrome: towards an understanding of the interactions between different compartments! *Intensive care medicine.* 2007; 33: 1869–1872.

7. Malbrain ML: Different techniques to measure intra-abdominal pressure (IAP): time for a critical re-appraisal. *Intensive Care Med* 2004; 30: 357–371.
8. De Potter TJ, Dits H, Malbrain ML: Intra- and interobserver variability during *in vitro* validation of two novel methods for intra-abdominal pressure monitoring. *Intensive Care Med* 2005; 31: 747–751.
9. Malbrain ML, De laet I, Viaene D, Schoonheydt K, Dits H: *In vitro* validation of a novel method for continuous intra-abdominal pressure monitoring. *Intensive Care Med* 2008; 34: 740–745.
10. Gaidukov KM, Raibuzhis EN, Hussain A et al.: Effect of intra-abdominal pressure on respiratory function in patients undergoing ventral hernia repair. *World J Crit Care Med* 2013; 2: 9–16.
11. Wauters J, Spincemaille L, Dieudonne AS, Van Zwam K, Wilmer A, Malbrain ML: A Novel Method (CiMON) for continuous intra-abdominal pressure monitoring: pilot test in a pig model. *Crit Care Res Pract* 2012; 2012: 181563.
12. De Waele JJ, De laet I, Malbrain ML: Rational intraabdominal pressure monitoring: how to do it? *Acta Clin Belg Suppl* 2007; 62: 16–25.
13. Balogh Z, De Waele JJ, Malbrain ML: Continuous intra-abdominal pressure monitoring. *Acta Clin Belg Suppl* 2007; 62: 26–32.
14. Nimmo AF, Drummond GB: Respiratory mechanics after abdominal surgery measured with continuous analysis of pressure, flow and volume signals. *Br J Anaesth* 1996; 77: 317–326.
15. Sugarman H, Windsor A, Bessos M, Wolfe L: Intra-abdominal pressure, sagittal abdominal diameter and obesity comorbidity. *J Intern Med* 1997; 241: 71–79.
16. Mulier J, Dillemans B, Crombach M, Missant C, Sels A: On the abdominal pressure volume relationship. *The Internet Journal of Anesthesiology* 2008; 21(1) www.ispub.com/ija/21/1/5221.
17. Mulier JP, Dillemans B, Heremans L: Determinants of the abdominal pressure volume relation in non ACS patients. *Acta Clin Belg Suppl* 2007; 62: 289.
18. Malbrain ML, Chiumello D, Pelosi P et al.: Prevalence of intra-abdominal hypertension in critically ill patients: a multicentre epidemiological study. *Intensive Care Med* 2004; 30: 822–829.
19. Malbrain ML, Chiumello D, Pelosi P et al.: Incidence and prognosis of intraabdominal hypertension in a mixed population of critically ill patients: a multiple-center epidemiological study. *Crit Care Med* 2005; 33: 315–322.
20. Mulier JP, Coenegrachts K, Van de Moortele K: CT analysis of the elastic deformation and elongation of the abdominal wall during colon insufflation for virtual colonoscopy. *Eur J Anaesthesiol* 2008; 25: 42.
21. Brook RD, Glazewski L, Rajagopalan S, Bard RL: Hypertension and triglyceride catabolism: implications for the hemodynamic model of the metabolic syndrome. *J Am Coll Nutr* 2003; 22: 290–295.
22. Bacha F, Saad R, Gungor N, Janosky J, Arslanian SA: Obesity, regional fat distribution, and syndrome x in obese black versus white adolescents: race differential in diabetogenic and atherogenic risk factors. *J Clin Endocrinol Metab* 2003; 88: 2534–2540.
23. Ascaso JF, Romero P, Real JT, Lorente RI, Martinez-Valls J, Carmena R: Abdominal obesity, insulin resistance, and metabolic syndrome in a southern European population. *Eur J Intern Med* 2003; 14: 101–106.
24. Yoshino O, Quail A, Oldmeadow C, Balogh ZJ: The interpretation of intra-abdominal pressures from animal models: The rabbit to human example. *Injury* 2012; 43: 169–173.
25. Malbrain ML, De laet I, Van Regenmortel N, Schoonheydt K, Dits H: Can the abdominal perimeter be used as an accurate estimation of intra-abdominal pressure? *Crit Care Med* 2009; 37: 316–369.
26. Guerrero-Romero F, Rodriguez-Moran M: Abdominal volume index. An anthropometry-based index for estimation of obesity is strongly related to impaired glucose tolerance and type 2 diabetes mellitus. *Arch Med Res* 2003; 34: 428–432.
27. Severgnini P, Inzignerri G, Olvera C et al.: New and old tools for abdominal imaging in critically ill patients. *Acta Clin Belg Suppl* 2007; 62: 173–182.
28. Kirkpatrick AW, Colistro R, Laupland KB et al.: Renal arterial resistive index response to intraabdominal hypertension in a porcine model*. *Crit Care Med.* 2007; 35: 207–213.
29. Vlot J, Wijnen R, Stolker RJ, Bax KN: Optimizing working space in laparoscopy: CT measurement of the effect of pre-stretching of the abdominal wall in a porcine model. *Surg Endosc* 2014; 28: 841–846.
30. Forstemann T, Trzewik J, Holste J et al.: Forces and deformations of the abdominal wall — a mechanical and geometrical approach to the linea alba. *J Biomech* 2011; 44: 600–606.

31. Accarino A, Perez F, Azpiroz F, Quiroga S, Malagelada JR: Abdominal distention results from caudo-ventral redistribution of contents. *Gastroenterology* 2009; 136: 1544–1551.
32. Cohen D, Timbs AE, Dalton KJ: Measurement of compliance of the maternal abdominal wall in pregnancy. *Eur J Obstet Gynecol Reprod Biol* 1986; 23: 267–272.
33. van Ramshorst GH, Lange JF, Goossens RH et al.: Non-invasive measurement of intra-abdominal pressure: a preliminary study. *Physiol Meas* 2008; 29: N41–N7.
34. van Ramshorst GH, Salih M, Hop WC et al.: Noninvasive assessment of intra-abdominal pressure by measurement of abdominal wall tension. *J Surg Res* 2011; 171: 240–244.
35. Wolf GK, Arnold JH: Noninvasive assessment of lung volume: respiratory inductance plethysmography and electrical impedance tomography. *Crit Care Med* 2005; 33 (Suppl): S163–9.
36. Cala SJ, Edyvean J, Engel LA: Abdominal compliance, parasternal activation, and chest wall motion. *J Appl Physiol* (1985). 1993; 74: 1398–1405.
37. Gilroy RJ, Jr., Lavietes MH, Loring SH, Mangura BT, Mead J: Respiratory mechanical effects of abdominal distention. *J Appl Physiol* 1985; 58: 1997–2003.
38. Abu-Rafea B, Vilos GA, Vilos AG, Hollett-Caines J, Al-Omran M: Effect of body habitus and parity on insufflated CO₂ volume at various intra-abdominal pressures during laparoscopic access in women. *J Minim Invasive Gynecol* 2006; 13: 205–210.
39. McDougall EM, Figenshau RS, Clayman RV, Monk TG, Smith DS: Laparoscopic pneumoperitoneum: impact of body habitus. *J Laparoendosc Surg* 1994; 4: 385–389.
40. Song C, Alijani A, Frank T, Hanna GB, Cuschieri A: Mechanical properties of the human abdominal wall measured *in vivo* during insufflation for laparoscopic surgery. *Surg Endosc* 2006; 20: 987–990.
41. Chassard D, Berrada K, Tournadre J, Bouletreau P: The effects of neuromuscular block on peak airway pressure and abdominal elastance during pneumoperitoneum. *Anesth Analg* 1996; 82: 525–537.
42. Obeid F, Saba A, Fath J et al.: Increases in intra-abdominal pressure affect pulmonary compliance. *Arch Surg* 1995; 130: 544–547.
43. Sugrue M, Buist MD, Lee A, Sanchez DJ, Hillman KM: Intra-abdominal pressure measurement using a modified nasogastric tube: description and validation of a new technique. *Intensive Care Med* 1994; 20: 588–590.
44. Reed SF, Britt RC, Collins J, Weireter L, Cole F, Britt LD: Aggressive surveillance and early catheter-directed therapy in the management of intra-abdominal hypertension. *J Trauma* 2006; 61: 1359–1363; discussion 63–65.
45. Becker V, Schmid RM, Umgelter A: Comparison of a new device for the continuous intra-gastric measurement of intra-abdominal pressure (CiMon) with direct intra-peritoneal measurements in cirrhotic patients during paracentesis. *Intensive care medicine*. *Intensive Care Med* 2009; 35: 948–952.
46. DeJardin A, Robert A, Goffin E: Intra-peritoneal pressure in PD patients: relationship to intraperitoneal volume, body size and PD-related complications. *Nephrol Dial Transplant* 2007; 22: 1437–1444.
47. Franklin JO, Alpert MA, Twardowski ZJ et al.: Effect of increasing intra-abdominal pressure and volume on left ventricular function in continuous ambulatory peritoneal dialysis (CAPD). *Am J Kidney Dis* 1988; 12: 291–298.
48. Durand PY, Chanliou J, Gamberoni J, Hestin D, Kessler M: Evolution of intraperitoneal hydrostatic pressure following peritoneal catheter implantation. *Adv Perit Dial* 1993; 9: 233–235.
49. de Jesus Ventura M, Amato D, Correa-Rotter R, Paniagua R: Relationship between fill volume, intraperitoneal pressure, body size, and subjective discomfort perception in CAPD patients. *Mexican Nephrology Collaborative Study Group*. *Perit Dial Int* 2000; 20: 188–193.
50. Paniagua R, Ventura Mde J, Rodriguez E et al.: Impact of fill volume on peritoneal clearances and cytokine appearance in peritoneal dialysis. *Perit Dial Int* 2004; 24: 156–162.
51. Harris KP, Keogh AM, Alderson L: Peritoneal dialysis fill volume: can the patient tell the difference? *Perit Dial Int* 2001; 21 (Suppl 3): S144–7.
52. Scanziani R, Dozio B, Baragetti I, Maroni S: Intra-peritoneal hydrostatic pressure and flow characteristics of peritoneal catheters in automated peritoneal dialysis. *Nephrol Dial Transplant* 2003; 18: 2391–2398.
53. Al-Hwiesh A, Al-Mueilo S, Saeed I, Al-Muhanna FA: Intra-peritoneal pressure and intra-abdominal pressure: are they the same? *Perit Dial Int* 2011; 31: 315–319.
54. Papavramidis TS, Duros V, Michalopoulos A, Papadopoulos VN, Paramythiotis D, Harlaftis N: Intra-abdominal pressure alterations after large pancreatic pseudocyst transcatheter drainage. *BMC Gastroenterology* 2009; 9: 42.
55. Papavramidis TS, Michalopoulos NA, Mistriotis G, Pliakos IG, Kesisoglou I, Papavramidis ST: Abdominal compliance, linearity between abdominal pressure and ascitic fluid volume. *J Emerg Trauma Shock*. 2011; 4: 194–197.
56. Horer T, Skoog P, Pirouzram A, Larzon T: Tissue plasminogen activator-assisted hematoma evacuation to relieve abdominal compartment syndrome after endovascular repair of ruptured abdominal aortic aneurysm. *J Endovasc Ther* 2012; 19: 144–148.
57. Malbrain MLNG, Jacobs A, De laet I, Van Regenmortel N, Schoonheydt K, Dits H: Incidence and prognosis of intra-abdominal hypertension and abdominal compartment syndrome in severely burned patients. *Intensive Care Med* 2010; 36 (Suppl. 2): S375, A1154.
58. Viaene D, De laet I, Van Regenmortel N et al.: Continuous direct intra-abdominal pressure monitoring and staged peritoneal drainage in patients with tense ascites. *Acta Clin Belg* 2007; 62 (Suppl. 1): 286.
59. Cheatham ML, Safcsak K: Percutaneous catheter decompression in the treatment of elevated intraabdominal pressure. *Chest* 2011; 140: 1428–1435.
60. De Keulenaer BL, De Backer A, Schepens DR, Daelemans R, Wilmer A, Malbrain ML: Abdominal compartment syndrome related to noninvasive ventilation. *Intensive Care Med* 2003; 29: 1177–1181.
61. Paal P, Neurauter A, Loedl M et al.: Effects of stomach inflation on haemodynamic and pulmonary function during cardiopulmonary resuscitation in pigs. *Resuscitation* 2009; 80: 365–371.
62. Paal P, Schmid S, Herff H, von Goedecke A, Mitterlechner T, Wenzel V: Excessive stomach inflation causing gut ischaemia. *Resuscitation* 2009; 80: 142.
63. Reintam Blaser A, Malbrain ML, Starkopf J et al.: Gastrointestinal function in intensive care patients: terminology, definitions and management. Recommendations of the ESICM Working Group on Abdominal Problems. *Intensive Care Med* 2012; 38: 384–394.
64. Emerson H: Intra-abdominal pressures. *Arch Intern Med* 1911; 7: 754–784.
65. Soler Morejon C, Tamargo Barbeito TO: Effect of mechanical ventilation on intra-abdominal pressure in critically ill patients without other risk factors for abdominal hypertension: an observational multicenter epidemiological study. *Ann Intensive Care* 2012; 2 (Suppl. 1): S22.
66. Verzilli D, Constantin JM, Sebbane M et al.: Positive end-expiratory pressure affects the value of intra-abdominal pressure in acute lung injury/acute respiratory distress syndrome patients: a pilot study. *Critical Care* 2010; 14: R137.
67. Egan M, Boutros A: Pneumoperitoneum following tension pneumothorax. Report of two cases. *Crit Care Med* 1975; 3: 170–172.
68. Alder AC, Hunt JL, Thal ER: Abdominal compartment syndrome associated with tension pneumoperitoneum in an elderly trauma patient. *J Trauma* 2008; 64: 211–212.
69. Wauters J, Wilmer A, Valenza F: Abdomino-thoracic transmission during ACS: facts and figures. *Acta Clin Belg Suppl* 2007; 62: 200–205.
70. Wauters J, Claus P, Brosens N et al.: Relationship between abdominal pressure, pulmonary compliance, and cardiac preload in a porcine model. *Crit Care Res Pract* 2012; 2012: 763181.
71. De laet I, Citerio G, Malbrain ML: The influence of intraabdominal hypertension on the central nervous system: current insights and clinical recommendations, is it all in the head? *Acta Clin Belg Suppl* 2007; 62: 89–97.
72. Pelosi P, Quintel M, Malbrain ML: Effect of intra-abdominal pressure on respiratory mechanics. *Acta Clin Belg Suppl* 2007; 62: 78–88.
73. De laet I, Malbrain ML, Jadoul JL, Rogiers P, Sugrue M: Renal implications of increased intra-abdominal pressure: are the kidneys the canary for abdominal hypertension? *Acta Clin Belg Suppl* 2007; 62: 119–130.
74. Ameloot K, Gillebert C, Desie N, Malbrain ML: Hypoperfusion, Shock States, and Abdominal Compartment Syndrome (ACS). *Surg Clin North Am* 2012; 92: 207–220.
75. Sturini E, Saporito A, Sugrue M, Parr MJ, Bishop G, Braschi A: Respiratory variation of intra-abdominal pressure: indirect indicator of abdominal compliance? *Intensive Care Med* 2008; 34: 1632–1637.
76. Ahmadi-Noorbakhs S, Malbrain ML: Integration of inspiratory and expiratory intra-abdominal pressure: a novel concept looking at mean intra-abdominal pressure. *Ann Intensive Care* 2012; 2 (Suppl 1): S18.
77. Malbrain MLNG, Van de Vijver K, Verstraeten AS et al.: The Respiratory Abdominal Variation Test (RAVT): a noninvasive way to estimate abdominal wall compliance (cab) at the bedside. *Am Surg* 2011; 77 (Suppl. 1): S98.

78. De Keulenaer BL, De Waele JJ, Powell B, Malbrain ML: What is normal intra-abdominal pressure and how is it affected by positioning, body mass and positive end-expiratory pressure? *Intensive Care Med* 2009; 35: 969–976.
79. Lambert DM, Marceau S, Forse RA: Intra-abdominal pressure in the morbidly obese. *Obes Surg* 2005; 15: 1225–1232.
80. Nguyen NT, Wolfe BM: The physiologic effects of pneumoperitoneum in the morbidly obese. *Ann Surg* 2005; 241: 219–226.
81. Sugerman HJ: Increased intra-abdominal pressure in obesity. *Int J Obes Relat Metab Disord* 1998; 22: 1138.
82. Verbeke K, Casier I, Van Acker B, Dillemans B, Mulier J: Impact of laparoscopy on the abdominal compliance is determined by the duration of the pneumoperitoneum the number of gravidity and the existence of a previous laparoscopy or laparotomy. *Eur J Anaesthesiol* 2010; 27: 29–30.
83. Sugerman H, Windsor A, Bessos M, Kellum J, Reines H, DeMaria E: Effects of surgically induced weight loss on urinary bladder pressure, sagittal abdominal diameter and obesity co-morbidity. *Int J Obes Relat Metab Disord* 1998; 22: 230–235.
84. Cheatham ML, Malbrain ML, Kirkpatrick A et al.: Results from the International Conference of Experts on Intra-abdominal Hypertension and Abdominal Compartment Syndrome. II. Recommendations. *Intensive Care Med* 2007; 33: 951–962.
85. De Keulenaer BL, De Waele JJ, Malbrain ML: Nonoperative management of intra-abdominal hypertension and abdominal compartment syndrome: evolving concepts. *Am Surg* 2011; 77 (Suppl. 1): S34–41.
86. De laet I, Malbrain ML: ICU management of the patient with intra-abdominal hypertension: what to do, when and to whom? *Acta Clin Belg Suppl* 2007; 62: 190–199.
87. Amaro R, Rogers AI: Neostigmine infusion: new standard of care for acute colonic pseudo-obstruction? *Am J Gastroenterol* 2000; 95: 304–305.
88. Cordemans C, De laet I, Van Regenmortel N et al.: Fluid management in critically ill patients: The role of extravascular lung water, abdominal hypertension, capillary leak and fluid balance. *Ann Intensive Care* 2012; 2 (Suppl. 1): S1.
89. Cordemans C, De laet I, Van Regenmortel N et al.: Aiming for a negative fluid balance in patients with acute lung injury and increased intra-abdominal pressure: a pilot study looking at the effects of PAL-treatment. *Ann Intensive Care* 2012; 2 (Suppl. 1): S15.
90. Cheatham ML, White MW, Sagraves SG, Johnson JL, Block EF: Abdominal perfusion pressure: a superior parameter in the assessment of intra-abdominal hypertension. *J Trauma* 2000; 49: 621–626; discussion 6–7.
91. Agustí M, Elizalde JJ, Adalia R, Cifuentes A, Fontanals J, Taura P: Dobutamine restores intestinal mucosal blood flow in a porcine model of intra-abdominal hyperpressure. *Crit Care Med* 2000; 28: 467–472.
92. Dubick MA, Williams C, Eljjo GI, Kramer GC: High-dose vitamin C infusion reduces fluid requirements in the resuscitation of burn-injured sheep. *Shock* 2005; 24: 139–144.
93. Drummond GB, Duncan MK: Abdominal pressure during laparoscopy: effects of fentanyl. *Br J Anaesth* 2002; 88: 384–388.
94. Tasdogan M, Memis D, Sut N, Yuksel M: Results of a pilot study on the effects of propofol and dexmedetomidine on inflammatory responses and intraabdominal pressure in severe sepsis. *J Clin Anesth* 2009; 21: 394–400.
95. Hakobyan RV, Mkhoyan GG: Epidural analgesia decreases intraabdominal pressure in postoperative patients with primary intra-abdominal hypertension. *Acta Clin Belg* 2008; 63: 86–92.
96. Malbrain M, Debaveye Y, Bertieaux S: Effect of abdominal compression and decompression on cardiorespiratory function and regional perfusion. *Intensive Care Med* 2000; 26 (Suppl. 3): Abstract 190: S264.
97. Tsoutsos D, Rodopoulou S, Keramidis E, Lagios M, Stamatopoulos K, Ioannovich J: Early escharotomy as a measure to reduce intraabdominal hypertension in full-thickness burns of the thoracic and abdominal area. *World J Surg* 2003; 27: 1323–1328.
98. Oda J, Ueyama M, Yamashita K et al.: Effects of escharotomy as abdominal decompression on cardiopulmonary function and visceral perfusion in abdominal compartment syndrome with burn patients. *J Trauma* 2005; 59: 369–374.
99. Bloomfield GL, Ridings PC, Blocher CR, Marmarou A, Sugerman HJ: A proposed relationship between increased intra-abdominal, intrathoracic, and intracranial pressure. *Crit Care Med* 1997; 25: 496–503.
100. Ali SZ, Freeman BD, Coopersmith CM: Abdominal compartment syndrome in a patient resulting from pneumothorax. *Intensive Care Med* 2003; 29: 1614.
101. McBeth PB, Zygun DA, Widder S et al.: Effect of patient positioning on intra-abdominal pressure monitoring. *Am J Surg* 2007; 193: 644–647.
102. Cheatham ML, De Waele JJ, De Laet I et al.: The impact of body position on intra-abdominal pressure measurement: a multicenter analysis. *Crit Care Med* 2009; 37: 2187–2190.
103. Kirkpatrick AW, Pelosi P, De Waele JJ et al.: Clinical review: Intra-abdominal hypertension: does it influence the physiology of prone ventilation? *Crit Care* 2010; 14: 232.
104. Michelet P, Roch A, Gannier M, Sainy JM, Auffray JP, Papazian L: Influence of support on intra-abdominal pressure, hepatic kinetics of indocyanine green and extravascular lung water during prone positioning in patients with ARDS: a randomized crossover study. *Crit Care* 2005; 9: R251–7.
105. Serpytis M, Ivaskевичius J: The influence of fluid balance on intra-abdominal pressure after major abdominal surgery. *Medicina (Kaunas)* 2008; 44: 421–427.
106. Cheatham ML, Malbrain ML: Cardiovascular implications of abdominal compartment syndrome. *Acta Clin Belg Suppl* 2007; 62: 98–112.
107. Malbrain ML: Is it wise not to think about intraabdominal hypertension in the ICU? *Curr Opin Crit Care* 2004; 10: 132–145.
108. Kula R, Szturz P, Sklienka P, Neiser J: Negative fluid balance in patients with abdominal compartment syndrome — case reports. *Acta Chir Belg* 2008; 108: 346–349.
109. Bonfim RF, Goulart AG, Fu C, Torquato JA: Effect of hemodialysis on intra-abdominal pressure. *Clinics (Paris)* 2007; 62: 145–150.
110. Mullens W, Abrahams Z, Francis GS, Taylor DO, Starling RC, Tang WH: Prompt reduction in intra-abdominal pressure following large-volume mechanical fluid removal improves renal insufficiency in refractory decompensated heart failure. *J Card Fail* 2008; 14: 508–514.
111. Deeren D, Dits H, Malbrain MLNG: Correlation between intra-abdominal and intracranial pressure in nontraumatic brain injury. *Intensive Care Med* 2005; 31: 1577–1581.
112. De Laet I, Hoste E, Verhoken E, De Waele JJ: The effect of neuromuscular blockers in patients with intra-abdominal hypertension. *Intensive Care Med* 2007.
113. De Waele JJ, Benoit D, Hoste E, Colardyn F: A role for muscle relaxation in patients with abdominal compartment syndrome? *Intensive Care Med* 2003; 29: 332.
114. Kimball EJ, Mone M: Influence of neuromuscular blockade on intra-abdominal pressure. *Crit Care Med* 2005; 33 (Suppl. 1): A38.
115. Mulier JP, Dillemans B, Van Cauwenberge S, Casier I, Lesaffer J: Is the laparoscopic inflation volume determined by the thickness of the rectus abdominus in obese patients? *Obes Surg* 2009; 19: 992: P–022.
116. Voss M, Pinheiro J, Reynolds J et al.: Endoscopic components separation for abdominal compartment syndrome. *Am J Surg* 2003; 186: 158–163.
117. Leppaniemi A, Hienonen P, Mentula P, Kemppainen E: Subcutaneous linea alba fasciotomy, does it really work? *Am Surg* 2011; 77: 99–102.
118. Pracca F, Biestro A, Gorrassi J, David M, Simini F, Cancela M: ABDOPRE: an external device for the reduction of intra-abdominal pressure. Preliminary clinical experience. *Rev Bras Ter Intensiva* 2011; 23: 238–241.
119. David M, Pracca F, Simini F: Non-invasive negative pressure system to treat abdominal hypertension. In: *Jobbágy Á (ed.): 5th European IFMBE Conference. 37. Budapest: Springer Science & Business Media* 2011: 211–214.
120. David M, Geido D, Pracca F, Sánchez G, Simini F, Zoppolo C: Negative pressure device for intraabdominal pressure reduction. *J Physics* 2007; 90 (Conference Series): 012035.
121. Saggi BH, Bloomfield GL, Sugerman HJ et al.: Treatment of intracranial hypertension using nonsurgical abdominal decompression. *J Trauma* 1999; 46: 646–651.
122. Sugerman HJ, Felton IW, III, Sismanis A et al.: Continuous negative abdominal pressure device to treat pseudotumor cerebri. *Int J Obes Relat Metab Disord* 2001; 25: 486–490.
123. Valenza F, Gattinoni L: Continuous negative abdominal pressure. In: *Ivatury R, Cheatham M, Malbrain M, Sugrue M (ed.): Abdominal compartment syndrome. Georgetown, Landes Bioscience* 2006: 238–251.
124. Valenza F, Irace M, Guglielmi M et al.: Effects of continuous negative extra-abdominal pressure on cardiorespiratory function during abdominal hypertension: an experimental study. *Intensive Care Med* 2005; 31: 105–111.
125. Valenza F, Bottino N, Canavesi K et al.: Intra-abdominal pressure may be decreased non-invasively by continuous negative extra-abdominal pressure (NEXAP). *Intensive Care Med* 2003; 29: 2063–2067.

126. *Denton WW*: John Wesley Young: lectures on fundamental concepts of algebra and geometry. William Wells Denton Mind, New Series 1912; 21: 445–448.
127. *De Waele JJ, Hoste EA, Malbrain ML*: Decompressive laparotomy for abdominal compartment syndrome — a critical analysis. *Crit Care* 2006; 10: R51.
128. *Van den Bussche E, Dillemans B, Feryn T, Mulier JP*: Effect of muscle relaxants on the abdominal pressure volume relation in bariatric laparoscopic surgery. *Surg Endosc* 2007; 21: 125.
129. *Malbrain ML, De laet IE, De Waele JJ*: IAH/ACS: the rationale for surveillance. *World J Surg* 2009; 33: 1110–1115.
130. *Ejike JC, Bahjri K, Mathur M*. What is the normal intra-abdominal pressure in critically ill children and how should we measure it? *Crit Care Med* 2008; 36: 2157–2162.
131. *Cheatham ML, De Waele J, De Keulenaer B et al.*: The effect of body position on intra-abdominal pressure measurement: a multicenter analysis. *Acta Clin Belg Suppl* 2007; 62: 246.
132. *Iberty TJ, Kelly KM, Gentili DR, Hirsch S, Benjamin E*: A simple technique to accurately determine intra-abdominal pressure. *Crit Care Med* 1987; 15: 1140–1142.
133. *Malbrain ML, Deeren DH*: Effect of bladder volume on measured intravesical pressure: a prospective cohort study. *Crit Care* 2006; 10: R98.
134. *De Waele J, Pletinckx P, Blot S, Hoste E*: Saline volume in transvesical intra-abdominal pressure measurement: enough is enough. *Intensive Care Med* 2006; 32: 455–459.
135. *Chiumello D, Tallarini F, Chierichetti M et al.*: The effect of different volumes and temperatures of saline on the bladder pressure measurement in critically ill patients. *Critic Care* 2007; 11: R82.
136. *Vallee F, Dupas C, Feuvrier V et al.*: Intra-abdominal pressure measurement method via the urinary-tube: bedside validation of a biomechanical model integrating urine column height and bladder urinary volume. *Ann Surg* 2010; 251: 127–132.
137. *Malbrain ML, De Laet IE, Willems A, Van Regenmortel N, Schoonheydt K, Dits H*: Localised abdominal compartment syndrome: bladder-over-gastric pressure ratio (B/G ratio) as a clue to diagnosis. *Acta Clin Belg* 2010; 65: 98–106.
138. *Cresswell AB, Jassem W, Srinivasan P et al.*: The effect of body position on compartmental intra-abdominal pressure following liver transplantation. *Ann Intensive Care* 2012; 2 (Suppl 1): S12.
139. *Malbrain ML, De laet I, De Waele JJ*: Continuous intra-abdominal pressure monitoring: this is the way to go! *Int J Clin Prac* 2008; 62: 359–362.
140. *Chiumello D, Gallazzi E, Marino A et al.*: A validation study of a new nasogastric polyfunctional catheter. *Intensive Care Med* 2011; 37: 791–795.
141. *Malbrain MLNG*: The great fluid debate: faith and evidence. *Intensive Care Monitor* 2014; 21: 1.
142. *Malbrain ML, De laet I*: Do we need to know body anthropomorphic data whilst measuring abdominal pressure? *Intensive Care Med* 2010; 36: 180–182.
143. *Burch JM, Moore EE, Moore FA, Franciose R*: The abdominal compartment syndrome. *Surg Clin North Am* 1996; 76: 833–842.
144. *Ivatury RR, Sugerman HJ, Peitzman AB*: Abdominal compartment syndrome: recognition and management. *Adv Surg* 2001; 35: 251–269.
145. *DuBay DA, Choi W, Urbanchek MG et al.*: Incisional herniation induces decreased abdominal wall compliance via oblique muscle atrophy and fibrosis. *Ann Surg* 2007; 245: 140–146.
146. *Konerding MA, Chantereau P, Delventhal V, Holste JL, Ackermann M*: Biomechanical and histological evaluation of abdominal wall compliance with intraperitoneal onlay mesh implants in rabbits: a comparison of six different state-of-the-art meshes. *MEMP* 2012; 34: 806–816.
147. *Tuggle D, Skinner S, Garza J, Vandijck D, Blot S*: The abdominal compartment syndrome in patients with burn injury. *Acta Clin Belg Suppl* 2007; 62: 136–140.
148. *Siddins M, Boland J, Riederer M, Kanchanabot B, Rao MM, Hewett P*: Influence of adhesive drapes on intraperitoneal volume and pressure during laparoscopy. *ANZ J Surg* 2002; 72: 553–556.
149. *O'Mara MS, Semins H, Hathaway D, Caushaj PF*: Abdominal compartment syndrome as a consequence of rectus sheath hematoma. *Am Surg* 2003; 69: 975–977.
150. *Barrio J, San Miguel G, Carrion JL*: Does profound neuromuscular block improve abdominal compliance in laparoscopic surgery? *Eur J Anaesthesiol* 2013; 30 (Suppl. 1): 146.
151. *Ogihara Y, Isshiki A, Kindscher JD, Goto H*: Abdominal wall lift versus carbon dioxide insufflation for laparoscopic resection of ovarian tumors. *J Clin Anesth* 1999; 11: 406–412.
152. *Raymondos K, Molitoris U, Capewell M et al.*: Negative- versus positive-pressure ventilation in intubated patients with acute respiratory distress syndrome. *Crit Care* 2012; 16: R37.

Corresponding author:

Manu Malbrain, MD, PhD
ICU and High Care Burn Unit Director
Ziekenhuis Netwerk Antwerpen
ZNA Stuivenberg, Lange Beeldekensstraat 267
B-2060 Antwerpen 6, Belgium
Tel: +32 3217 73 99
Fax: +32 3217 75 74
e-mail: manu.malbrain@skynet.be

Received: 1.09.2014
Accepted: 31.10.2014